



Prijslijst

Leveringsprogramma



Ponsnippel DIN 9861 D HWS

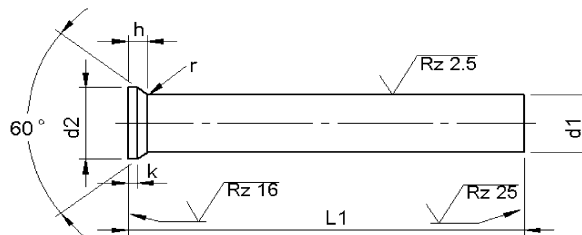
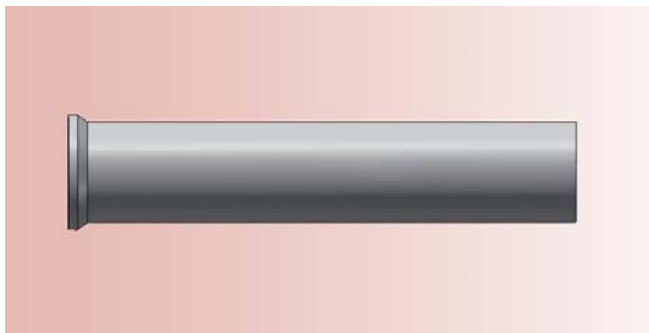

Materiaal: HWS (1.2379)

Hardheid: Schacht: 62 ±2 HRC

Kop: 50 ±5 HRC

UITLOPEND MATERIAAL

d ₁	h ₆	d ₂ +0.05 -0.05	k +0.2 0	l ₁ +0.5 0						
				71	80	90	100	120	150	
				Prijs per stuk in EURO						
0.5		0.9	0.2	5,09						
0.6		1.1		5,09						
0.7		1.3		4,84						
0.8		1.4	0.4	4,84						
0.9		1.6		4,84						
1.0	t/m	1.1		1.8	3,80	4,45	5,03	5,67		
1.2	t/m	1.3	2.0	3,80	4,45	5,03	5,67			
1.4	t/m	1.5	2.2	3,80	4,45	5,03	5,67			
1.6	t/m	1.7	2.5	3,80	4,45	5,03	5,67			
1.8	t/m	1.9	2.8	3,80	4,45	5,03	5,67			
2.0		3.0	0.5	3,55	3,87	4,45	4,96	7,16		
2.1	t/m	2.2		3.2	3,55	3,87	4,45	4,96	7,16	
2.3	t/m	2.5		3.5	3,55	3,87	4,45	4,96	7,16	
2.6	t/m	2.9		4.0	3,55	3,87	4,45	4,96	7,16	
3.0	t/m	3.4		4.5	3,55	3,87	4,45	4,96	7,16	
3.5	t/m	3.9		5.0	4,00	4,32	4,90	5,61	7,93	
4.0	t/m	4.4		5.5	3,68	4,13	4,58	5,16	7,35	10,96
4.5	t/m	4.9		6.0	4,00	4,26	4,77	5,61	7,93	11,86
5.0	t/m	5.4		6.5	4,00	4,26	4,77	5,61	7,93	11,86
5.5	t/m	5.9		7.0	4,00	4,32	5,09	5,61	7,93	11,93
6.0	t/m	6.4	8.0	4,00	4,32	5,09	5,61	7,93	11,93	
6.5	+	7.0	9.0	4,26	4,64	5,29	5,93	8,45	12,64	
7.5	+	8.0	10.0	4,45	4,84	5,61	6,13	8,83	13,22	
8.5	+	9.0	11.0	4,96	5,54	6,19	7,03	9,93	14,83	
9.5	+	10.0	12.0	6,00	6,58	7,48	8,45	11,93	17,86	
10.5	+	11.0	13.0	6,58	7,35	8,25	9,28	13,15	19,73	
11.5	+	12.0	14.0	7,48	8,19	9,28	10,44	14,96	22,44	
12.5	+	13.0	15.0	7,74	8,70	9,86	10,96	15,47	23,21	

Tusseliggende diameter of lengte en andere materialen zoals ASP, CPM en Vanadis, prijs op aanvraag.

Voor toeslagen en kortingen zie blad 2.

Gerimex b.v. Telefoon +31 74 2436655 . info@gerimex.com . www.gerimex.com

Ponsnippel DIN 9861 D HWS

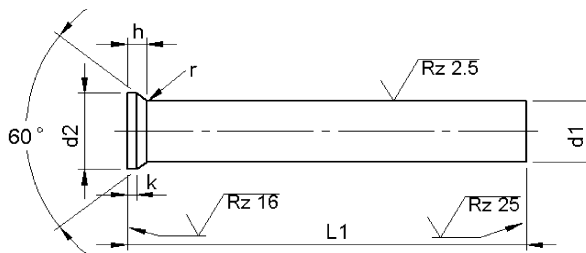
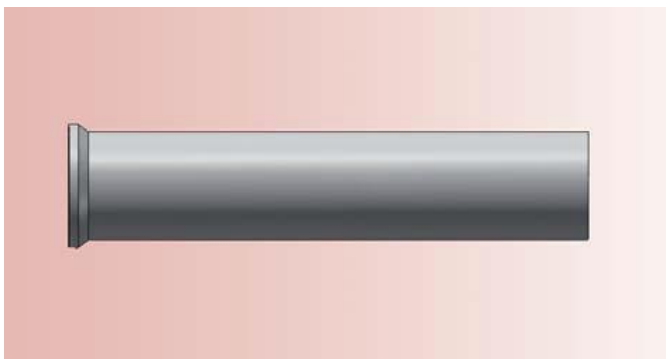

Materiaal: HWS (1.2379)
Hardheid: Schacht: 62 ±2 HRC
Kop: 50 ±5 HRC

UITLOPEND MATERIAAL

d ₁			d ₂ +0.05 -0.05	k +0.2 0	l ₁ +0.5 0					
					71	80	90	100	120	150
h ₆			Prijs per stuk in EURO							
13.5	+	14.0	16.0	1.5	9,03	9,99	11,28	12,70	18,05	27,08
14.5	+	15.0	17.0		10,83	11,93	13,60	15,21	21,60	32,43
15.5	+	16.0	18.0		12,06	13,34	15,09	16,89	24,05	36,10
16.5			19.0		12,51	13,73	15,60	17,54	24,95	37,46
17.0			19.5		12,51	13,73	15,60	17,54	24,95	37,46
17.5			20.0		13,41	14,70	17,86	18,82	26,75	40,16
18.0			20.5	13,41	14,70	17,86	18,82	26,75	40,16	
18.5			21.0	14,31	15,73	18,44	20,05	28,62	42,87	
19.0			21.5	14,31	15,73	18,44	20,05	28,62	42,87	
19.5			22.0	15,21	16,76	19,02	21,27	30,43	45,58	
20.0			22.5	15,21	16,76	19,02	21,27	30,43	45,58	
20.5			23.0	2.0	16,12	17,73	20,18	22,56	32,23	48,22
21.0			23.5		16,12	17,73	20,18	22,56	32,23	48,22
21.5			24.0		17,02	18,76	21,27	23,79	34,04	51,06
22.0			24.5		17,02	18,76	21,27	23,79	34,04	51,06
22.5			25.0		17,92	19,66	22,43	25,14	35,84	53,77
23.0			25.5		17,92	19,66	22,43	25,14	35,84	53,77
23.5			26.0		18,82	20,69	23,53	26,37	37,65	56,47
24.0			26.5		18,82	20,70	23,53	26,37	37,65	56,47
24.5			27.0		19,73	21,73	24,69	27,66	39,45	59,18
25.0			27.5		19,73	21,73	24,69	27,66	39,45	59,18

Tussenliggende diameter of lengte en andere materialen zoals ASP, CPM en Vanadis, prijs op aanvraag.

Toeslagen en kortingen:

1 stuks per afmeting	+ 50%
2-3 stuks per afmeting	+ 25%
25 stuks per afmeting	- 5%
50 stuks per afmeting	- 7%
100 stuks per afmeting	- 10%

Ponsnippel DIN 9861 D HSS

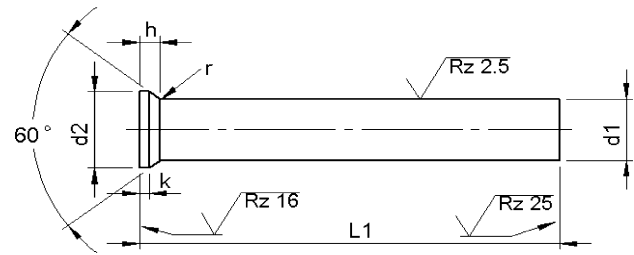
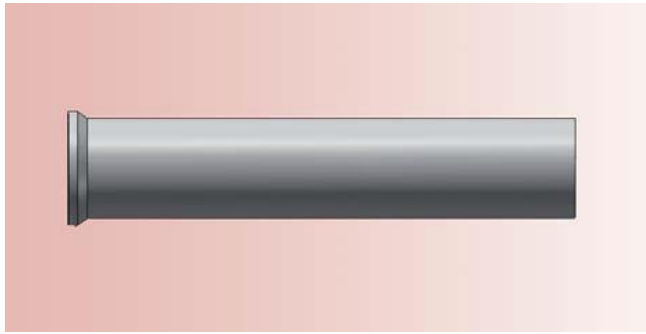

Materiaal: HSS (1.3379)
Hardheid: Schacht: 64 ±2 HRC
Kop: 50 ±5 HRC

d ₁	h ₆	d ₂ +0.05 -0.05	k +0.2 0	l ₁ +0.5 0						
				71	80	90	100	120	150	
Prijs per stuk in EURO										
0.5		0.9	0.2	6,01						
0.6		1.1		6,01						
0.7		1.3		5,69						
0.8		1.4	0.4	5,69						
0.9		1.6		5,69						
1.0	t/m	1.1	0.5	4,65	5,24	5,82	6,53			
1.2	t/m	1.3		4,65	5,24	5,82	5,24			
1.4	t/m	1.5		4,65	5,24	5,82	5,24			
1.6	t/m	1.7		4,65	5,24	5,82	5,24			
1.8	t/m	1.9		4,65	5,24	5,82	5,24			
2.0		3.0		4,27	4,65	5,36	5,88	8,47		
2.1	t/m	2.2		4,27	4,65	5,36	5,88	8,47		
2.3	t/m	2.5		4,27	4,65	5,36	5,88	8,47		
2.6	t/m	2.9		4,27	4,65	5,36	5,88	8,47		
3.0	t/m	3.4		4,27	4,65	5,36	5,88	8,47		
3.5	t/m	3.9		4,65	5,24	5,82	6,53	9,31		
4.0	t/m	4.4		4,27	4,65	5,36	5,88	8,47		
4.5	t/m	4.9		4,65	5,24	5,82	6,53	9,31	13,90	
5.0	t/m	5.4		4,91	5,43	6,01	6,85	9,70	14,54	
5.5	t/m	5.9		4,85	5,43	6,01	6,85	9,70	14,54	
6.0	t/m	6.4	4,85	5,43	6,01	6,85	9,70	14,54		
6.5	+	7.0	1.0	5,36	5,75	6,59	7,37	10,66	15,97	
7.5	+	8.0		5,49	5,95	6,92	7,63	10,92	16,35	
8.5	+	9.0		6,01	6,66	7,43	8,40	11,96	17,90	
9.5	+	10.0		7,11	7,89	8,86	9,95	14,16	21,20	
10.5	+	11.0		7,95	8,66	9,82	11,12	15,84	23,72	
11.5	+	12.0		8,66	9,57	10,79	12,15	17,26	25,85	
12.5	+	13.0		10,60	11,57	13,19	14,74	21,14	31,74	

Tusseliggende diameter of lengte en andere materialen zoals ASP, CPM en Vanadis, prijs op aanvraag.

Voor toeslagen en kortingen zie blad 2.

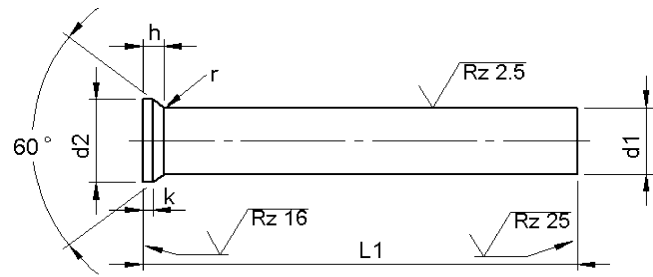
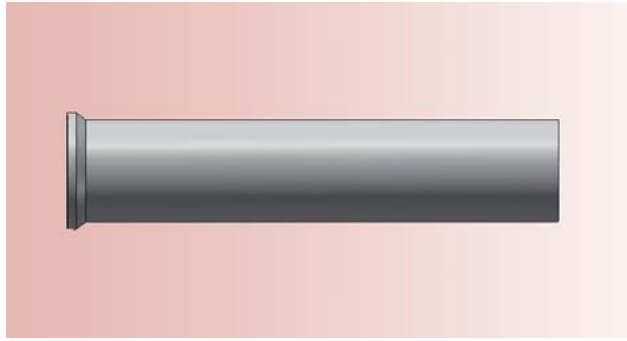

Materiaal: HSS (1.3379)
Hardheid: Schacht: 64 ±2 HRC
Kop: 50 ±5 HRC

d ₁			d ₂ +0.05 -0.05	k +0.2 0	l ₁ +0.5 0					
					71	80	90	100	120	150
h ₆			Prijs per stuk in EURO							
13.5	+	14.0	16.0	1.5	12,15	13,25	15,12	16,87	24,24	36,39
14.5	+	15.0	17.0		12,99	14,28	16,22	18,16	25,98	38,91
15.5	+	16.0	18.0		14,54	15,97	18,16	20,36	29,09	43,63
16.5			19.0	2.0	14,93	16,42	18,68	20,88	29,86	44,79
17.0			19.5		14,93	16,42	18,68	20,88	29,86	44,79
17.5			20.0		15,90	17,52	19,91	22,30	31,80	47,70
18.0			20.5		15,90	17,52	19,91	22,30	31,80	47,70
18.5			21.0		16,87	18,55	21,07	23,59	33,74	37,62
19.0			21.5		16,87	18,55	21,07	23,59	33,74	37,62
19.5			22.0		17,84	19,65	22,30	25,01	35,68	55,46
20.0			22.5		17,84	19,65	22,30	25,01	35,68	55,46
20.5			23.0		18,81	20,68	23,46	26,31	37,49	56,23
21.0			23.5		19,26	20,68	23,46	26,31	37,49	57,78
21.5			24.0		19,78	21,72	24,69	27,66	39,56	59,34
22.0			24.5		19,78	21,72	24,69	27,66	39,56	59,34
22.5			25.0		20,75	22,23	25,92	29,02	27,28	62,24
23.0			25.5		20,75	22,23	25,92	29,02	41,50	62,24
23.5			26.0		21,72	23,85	27,08	30,38	43,44	65,15
24.0			26.5	21,72	23,85	27,08	30,38	43,44	65,15	
24.5			27.0	22,69	24,95	28,31	31,74	45,37	68,06	
25.0			27.5	22,69	24,95	28,31	31,74	45,37	68,07	

Tussenliggende diameter of lengte en andere materialen zoals ASP, CPM en Vanadis, prijs op aanvraag.

Voor toeslagen en kortingen zie blad 2.

Toeslagen en kortingen:

- 1 stuks per afmeting + 50%
- 2-3 stuks per afmeting + 25%
- 25 stuks per afmeting - 5%
- 50 stuks per afmeting - 7%
- 100 stuks per afmeting - 10%

Ronde aanslijping aan DIN 9861 C

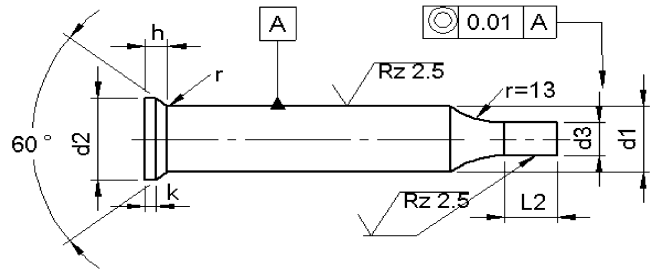
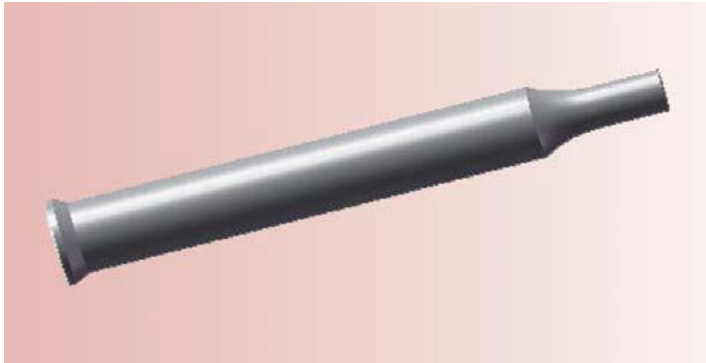

d ₁	d ₃ h ₆			l ₂ +0.5 0				
				Meerprijs voor een aanslijping in EURO				
≥	≥	-	≤	7	10	13	17	
1.5	0.5	-	1.4	•				3,22
2	0.5	-	1.9	•				3,22
3	1.6	-	2.9	•				3,22
4	1.6	-	3.9		•			3,22
5	2.5	-	4.9		•			3,55
6	3	-	5.9		•			4,13
8	4	-	7.9			•		4,83
10	5	-	9.9				•	5,73
13	9	-	12.9				•	6,57
16	12	-	15.9				•	8,96
20	16	-	19.9				•	12,44
25	20	-	24.9				•	16,55
32	25	-	31.9				•	20,24
38	30	-	37.9				•	21,98

Profielaanslijping aan DIN 9861

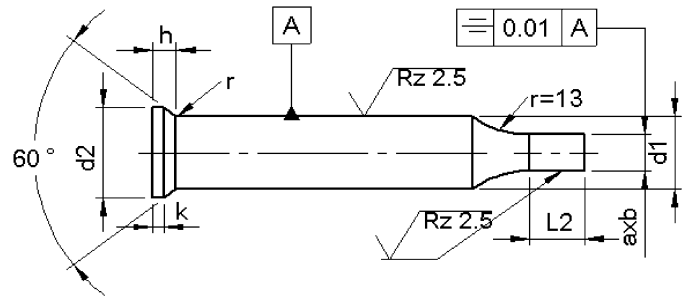

type ..S type ..R type ..O type ..F

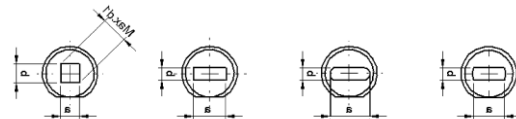

d ₁	AxB ± 0,01			l ₁ +0.5 0				
	B	-	A	Meerprijs voor profiel in EURO				
≥	≥	-	≤	10	13	17	Borgvlak	
5	2,5	-	4,9	•			20,31	6,10
6	3,0	-	5,9	•			22,33	
8	4,0	-	7,9		•		27,07	8,15
10	5,0	-	9,9			•	27,07	
13	9,0	-	12,9			•	27,07	
16	12,0	-	15,9			•	27,07	11,15
20	16,0	-	19,9			•	40,53	
25	20,0	-	24,9			•	47,39	12,95
32	27,0	-	31,9			•	54,22	
38	33,0	-	37,9			•	54,22	

L2 -max is 7x de maat b met een max. van 40 mm.

De profielnippel kan tegen meerprijs met borgvlak geleverd worden.

Deze wordt dan standaard evenwijdig aan de a-maat geslepen.

Ponsnippel ISO 8020 A / type K

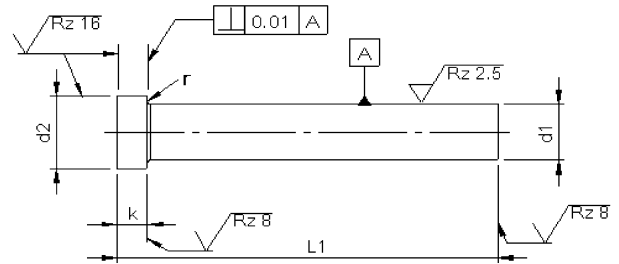
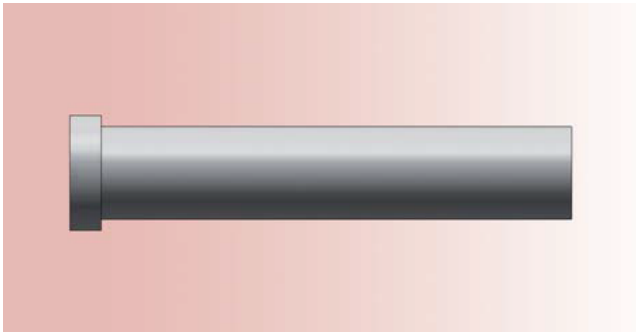

Materiaal: HSS (1.3343)
Hardheid: Schacht: 64 ±2 HRC
Kop: 50 ±5 HRC

d ₁ m5	Type K		ISO 8020 A		r +0.1 0	l ₁ +0.5 +0.2				
	d ₂ 0 -0.15	k +0.2 +0.1	d ₂ 0 -0.15	k +0.2 +0.1		63/71	80	90	100	120
3	5	3	5	3	0.2	7,42	8,12	9,29		
4	6	3	6	3		7,42	8,12	9,29	10,38	
5	8	5	8	5	0.3	7,42	8,19	9,03	9,87	11,30
6	9	5	9	5		8,51	9,42	10,31	11,35	12,96
8	11	5	11	5		10,06	11,10	12,18	13,41	15,36
10	13	5	13	5		11,80	12,96	14,25	15,67	17,93
13	16	5	16	5	0.4	14,90	16,38	17,99	19,80	22,60
16	19	6	19	5		18,31	20,11	22,18	24,37	27,88
20	24	6	23	5		22,25	24,43	26,88	29,53	33,83
25	29	10	28	5		27,59	30,37	33,40	36,75	42,07
32	36	12	35	5		36,55	40,23	44,23	48,67	55,69
38	45	15	41	5		45,07	49,58	54,54	59,96	68,71

Tussenliggende diameter of lengte en andere materialen zoals ASP,CPM en Vanadis, prijs op aanvraag.

Toeslagen en kortingen:

- 1 stuks per afmeting + 50%
- 2-3 stuks per afmeting + 25%
- 25 stuks per afmeting - 5%
- 50 stuks per afmeting - 7%
- 100 stuks per afmeting - 10%

Ponsnippel ISO 8020 B / type KP

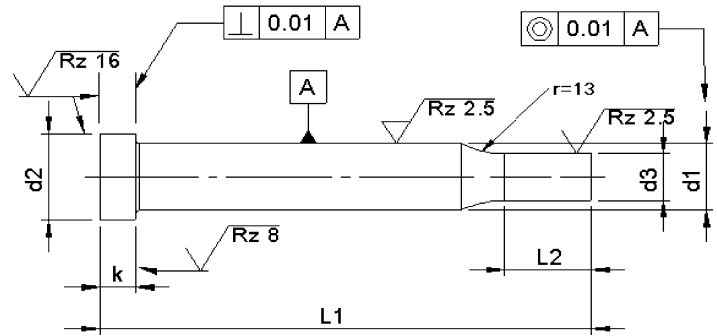
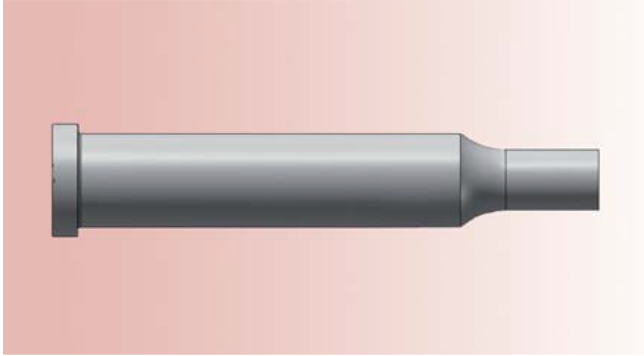

Materiaal: HSS (1.3343)
Hardheid: Schacht: 64 ±2 HRC
Kop: 50 ±5 HRC

d ₁ m5	d ₃ j6		l ₂ +0.5 0	l ₁ +0.5 +0.2				
	≥	≤		63/71	80	90	100	120
				Prijs per stuk in EURO				
3	1.6	– 2.9	7	10,64	11,35	12,51		
4	1.6	– 3.9	10	10,64	11,35	12,51	13,60	
5	2.5	– 4.9	10	10,96	11,73	12,57	13,41	15,41
6	3.0	– 5.9	10	12,64	13,54	14,44	15,47	17,73
8	4.0	– 7.9	13	14,89	15,93	17,02	18,25	20,95
10	5.0	– 9.9	17	17,54	18,70	19,99	21,41	24,56
13	9.0	– 12.9	17	21,34	22,95	24,56	26,37	30,30
16	12.0	– 15.9	17	27,27	29,08	31,08	33,33	38,17
20	16.0	– 19.9	17	34,62	36,88	39,33	41,97	47,97
25	20.0	– 24.9	17	43,65	46,42	49,45	52,80	60,22
32	27.0	– 31.9	17	56,80	60,48	64,47	68,92	78,72
38	33.0	– 37.9	17	67,05	71,57	76,53	81,95	113,35

Tusseliggende diameter of lengte en andere materialen zoals ASP,CPM en Vanadis, prijs op aanvraag.

Toeslagen en kortingen:

1 stuks per afmeting	+ 50%
2-3 stuks per afmeting	+ 25%
25 stuks per afmeting	– 5%
50 stuks per afmeting	– 7%
100 stuks per afmeting	– 10%

Ponsnippel ISO 8020 B / type K..

Met standaard profielaanslijping



Blad 2.03

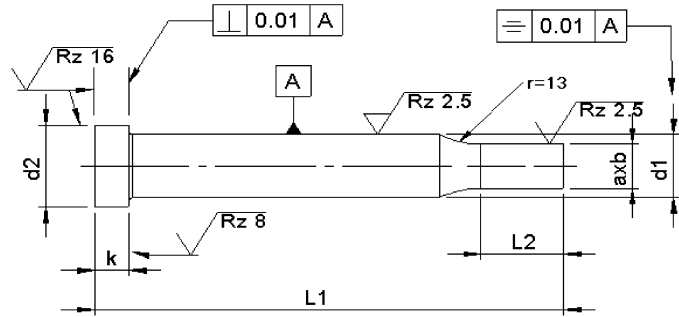
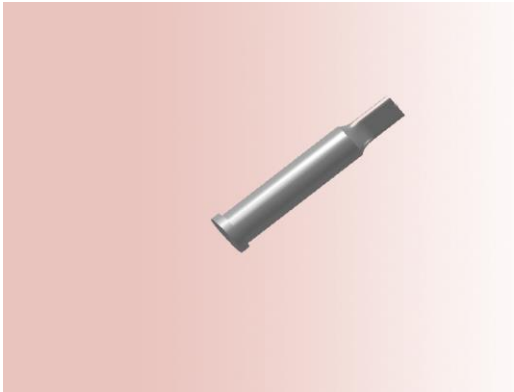

Materiaal: HSS (1.3343)
Hardheid: Schacht: 64 ±2 HRC
Kop: 50 ±5 HRC

type..F type..O type..R type..S

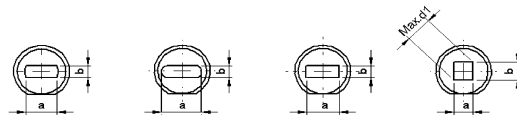

d ₁	AxB		l ₂	l ₁					
	± 0,01			63/71	80	90	100	120	Borgvlak
m5	B ≥	A ≤		Prijs per stuk in EURO					
3	1.6	2.9	7	27,45	28,21	28,98	29,87		6,10
4	1.6	3.9	10	27,45	28,21	28,98	29,87		
5	2.5	4.9	10	27,45	28,21	28,98	29,87	31,85	
6	3.0	5.9	10	28,53	29,43	30,32	31,34	33,57	8,15
8	4.0	7.9	13	36,77	37,79	38,87	40,08	42,77	
10	5.0	9.9	17	38,49	39,64	40,91	42,32	45,45	
13	9.0	12.9	17	41,55	43,02	44,62	46,40	50,30	11,15
16	12.0	15.9	17	44,94	46,72	48,77	50,94	55,79	
20	16.0	19.9	17	62,23	64,40	66,83	69,45	75,38	
25	20.0	24.9	17	74,23	76,98	79,98	83,30	90,64	12,95
32	27.0	31.9	17	89,81	93,45	97,40	101,81	108,96	14,70
38	33.0	37.9	17	98,23	102,70	107,62	112,98	125,10	

De profielnippel kan tegen meerprijs met borgvlak geleverd worden.
 Standaard wordt het borgvlak evenwijdig aan de a maat gemaakt.
 Tusseliggende diameter of lengte en anderde materialen zoals ASP , CPM en Vanadis, prijs op aanvraag

Toeslagen en kortingen:

- 1 stuks per afmeting + 50%
- 2-3 stuks per afmeting + 25%
- 25 stuks per afmeting - 5%
- 50 stuks per afmeting - 7%
- 100 stuks per afmeting - 10%

Gerimex b.v. Telefoon +31 74 2436655 . info@gerimex.com . www.gerimex.com

Ponsnippel ISO 8020 PL / type KPL

Met zoeker aangeslepen



Blad 2.04

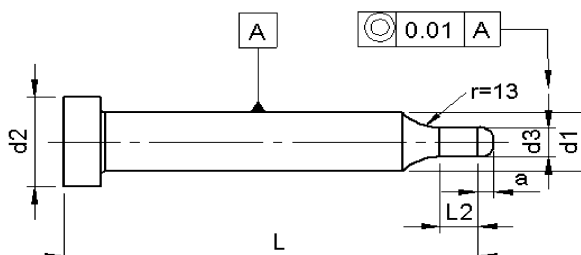

Materiaal: HSS (1.3343)
Hardheid: Schacht: 64 ±2 HRC
 Kop: 50 ±5 HRC

d ₁	d ₃			a	l ₂	l+a				
	+0.01 0					63/71	80	90	100	120
m ₅	≥	-	≤	Prijs per stuk in EURO						
5	0.8	-	2.0	3.0	10	14,50	15,28	16,12	16,95	18,96
6	2.1	-	4.5	4.5	10	16,77	17,66	18,57	19,60	21,86
8	4.6	-	7.5	6.5	13	19,73	20,76	21,85	23,08	25,79
10	7.6	-	10.0	8.0	17	23,28	24,43	25,73	27,15	30,30
13	10.1	-	13.0	9.5	17	27,92	29,53	31,14	32,95	36,88
16	13.1	-	16.0	11.5	17	36,24	38,05	40,04	42,29	47,13
20	16.1	-	20.0	13.5	17	47,06	49,33	51,78	54,41	60,41
25	20.1	-	25.0	13.5	17	59,70	63,25	65,51	68,86	76,27

Tusseliggende diameter of lengte en andere materialen zoals ASP,CPM en Vanadis, prijs op aanvraag.

Toeslagen en kortingen:

1 stuks per afmeting	+ 50%
2-3 stuks per afmeting	+ 25%
25 stuks per afmeting	- 5%
50 stuks per afmeting	- 7%
100 stuks per afmeting	- 10%

Gerimex b.v. Telefoon +31 74 2436655 . info@gerimex.com . www.gerimex.com

Ponsnippel ISO 8020 E / type EK

Met verende uitwerper



Bald 2.05

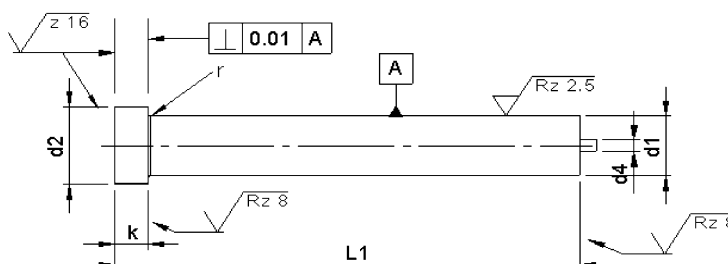
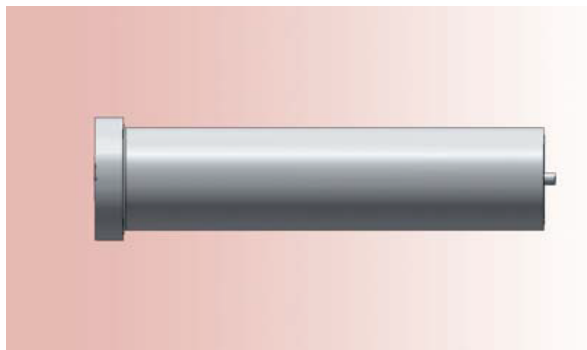

Materiaal: HSS (1.3343)
Hardheid: Schacht: 64 ±2 HRC
Kop: 50 ±5 HRC

d ₁	d ₂	d ₄	k	r	l ₁				
					63/71	80	90	100	120
m ₅	0 -0.15		+0.2 +0.1	+0.1 0	Prijs per stuk in EURO				
5	8	1	5	0.3	20,96	23,08	25,40	27,92	
6	9		5		20,70	22,83	25,08	27,59	
8	11	1,5	5		20,88	23,02	25,27	27,86	33,40
10	13		5		22,63	24,89	27,34	30,11	36,11
13	16	2,3	5	0.5	25,73	28,25	31,08	34,17	41,00
16	19		5		29,14	32,05	35,27	38,82	46,55
20	23	5	33,08		36,36	39,97	43,97	52,80	
25	28	5	38,43		42,29	46,48	51,12	61,38	
32	35	3	5		48,62	52,42	56,67	65,90	69,37
38	41		5		56,03	60,80	65,51	70,99	82,98

Tusseliggende diameter of lengte en andere materialen zoals ASP,CPM en Vanadis, prijs op aanvraag.

Toeslagen en kortingen:

1 stuks per afmeting	+ 50%
2-3 stuks per afmeting	+ 25%
25 stuks per afmeting	- 5%
50 stuks per afmeting	- 7%
100 stuks per afmeting	- 10%

Ponsnippel ISO 8020 F / type EKP

Met verende uitwerper met ronde aanslijping

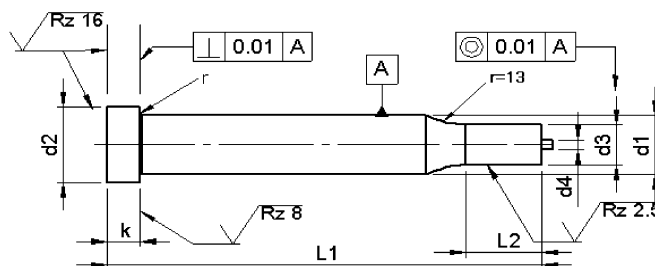
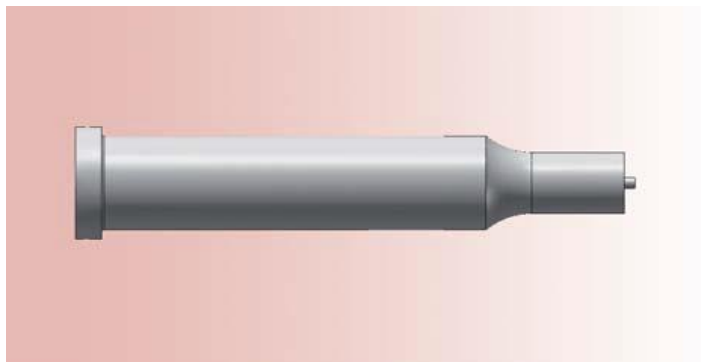

Materiaal: HSS (1.3343)
Hardheid: Schacht: 64 ±2 HRC
 Kop: 50 ±5 HRC

d ₁ m ₅	≥	d ₃ j ₆ -	≤	l ₂	l ₁				
					+0,5				
					+0,2				
					63/71	80	90	100	120
Prijs per stuk in EURO									
5	2.5	-	4.9	10	24,18	26,62	28,95	31,46	
6	3.0	-	5.9	10	24,89	26,96	29,20	31,72	
8	4.0	-	7.9	13	25,73	27,85	30,11	32,69	38,23
10	5.0	-	9.9	17	28,37	30,63	33,07	35,85	41,84
13	9.0	-	12.9	17	32,30	34,82	37,65	40,75	47,59
16	12.0	-	15.9	17	38,11	41,01	44,24	47,77	55,51
20	16.0	-	19.9	17	45,53	48,80	52,41	56,42	65,25
25	20.0	-	24.9	17	54,48	58,35	62,55	66,53	77,43
32	24.0	-	31.9	17	67,83	71,44	75,50	79,89	89,69
38	28.0	-	37.9	17	78,08	82,85	87,56	93,04	105,22

Tussenliggende diameter of lengte en andere materialen zoals ASP,CPM en Vanadis, prijs op aanvraag.

Toeslagen en kortingen:

1 stuks per afmeting	+ 50%
2-3 stuks per afmeting	+ 25%
25 stuks per afmeting	- 5%
50 stuks per afmeting	- 10%
100 stuks per afmeting	- 15%

Ponsnippel ISO 8020 E / type EK..

Met verende uitwerper met standaard profielaanslijping



Blad 2.07

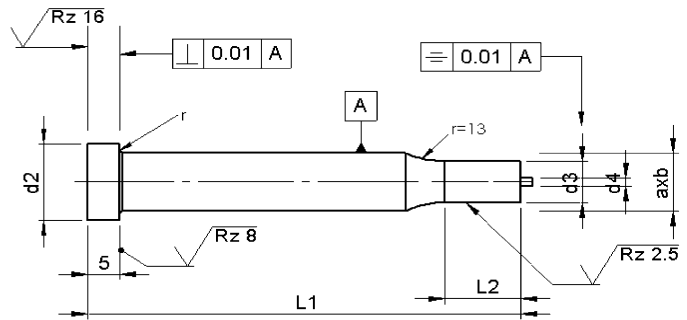

type..F

type..O

type..R

type..S

Materiaal: HSS (1.3343)
 Hardheid: Schacht: 64 ±2 HRC
 Kop: 50 ±5 HRC

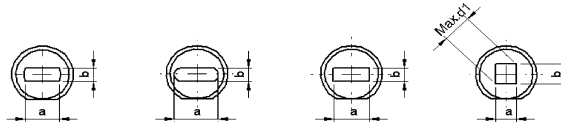

d ₁	AxB ± 0.01			l ₂	l ₁					
	B ≥	-	A ≤		63/71	80	90	100	120	Borgvlak
					Prijs per stuk in EURO					
5	2.5	-	4.9	10	41,26	43,39	45,71	48,23		6,10
6	3.0	-	5.9	10	41,01	43,13	45,39	47,90		
8	4.0	-	7.9	13	47,97	50,10	52,35	54,93	60,48	8,15
10	5.0	-	9.9	17	49,71	51,97	54,42	57,19	63,18	
13	9.0	-	12.9	17	52,80	55,32	58,16	61,25	68,08	
16	12.0	-	15.9	17	56,22	59,12	62,35	65,89	73,63	11,15
20	16.0	-	19.9	17	73,69	76,98	80,59	84,59	93,42	
25	20.0	-	24.9	17	85,82	89,68	93,94	98,58	108,77	
32	24.0	-	31.9	17	102,84	106,58	110,83	120,05	123,53	14,70
38	28.0	-	37.9	17	110,25	114,96	119,66	125,27	137,14	

Tusseliggende diameter of lengte en andere materialen zoals ASP,CPM en Vanadis, prijs op aanvraag.

Toeslagen en kortingen:

- 1 stuks per afmeting + 50%
- 2-3 stuks per afmeting + 25%
- 25 stuks per afmeting - 5%
- 50 stuks per afmeting - 7%
- 100 stuks per afmeting - 10%

Gerimex b.v. Telefoon +31 74 2436655 . info@gerimex.com . www.gerimex.com

Posaunenhals type P

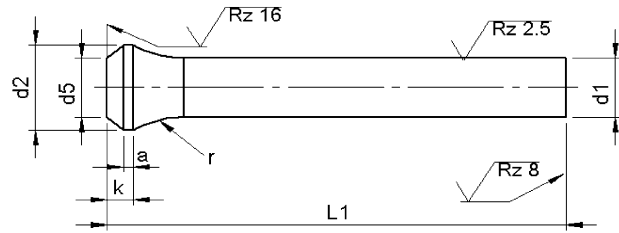
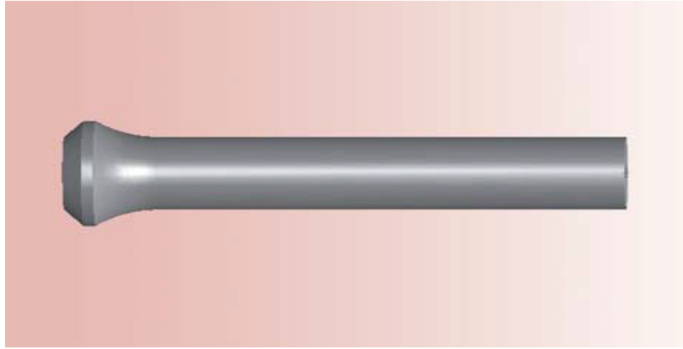

Materiaal: HSS (1.3343)
Hardheid: Schacht: 64 ±2 HRC
Kop: 50 ±5 HRC

d ₁ h ₆	d ₂ 0 -0.2	k +0.2 0	a	d ₅	r 0 -0.2	l ₁ +0.5 0				
						71	80	90	100	120
						Prijs per stuk in EURO				
5,0	7,0	4,0	1,5	d1 ± 0,1	10,0	7,42	8,19	9,03	9,87	11,87
5,5	8,0					7,93	8,77	9,67	10,57	12,60
6,0	9,0					8,51	9,42	10,31	11,35	13,61
6,5	10,0				12,0	8,90	9,80	10,77	11,87	14,19
7,0	10,0					9,29	10,19	11,22	12,38	14,83
7,5	11,0					9,67	10,57	11,67	12,89	15,47
8,0	11,0				15,0	10,06	11,10	12,18	13,41	16,12
8,5	13,0					10,51	11,54	12,71	13,99	16,77
9,0	13,0					10,96	11,99	13,22	14,37	17,41
9,5	14,0					11,41	12,45	13,73	14,96	18,05
10,0	14,0					11,80	12,96	14,25	15,67	18,83
10,5	15,0					12,32	13,60	14,90	16,35	19,64
11,0	15,0					12,83	14,25	15,54	17,03	20,45
11,5	16,0					13,35	14,90	16,18	17,72	21,27
12,0	16,0					13,73	15,54	16,82	18,40	22,07
12,5	17,0					14,32	15,54	17,48	19,09	22,89
13,0	17,0	14,90	16,38	17,99	19,80	23,73				
13,5	18,0	15,47	17,00	18,63	20,57	24,63				
14,0	18,0	16,05	17,62	19,27	21,34	25,53				
14,5	19,0	16,64	18,24	19,93	22,12	26,44				

Tusseliggende diameter of lengte en andere materialen zoals ASP,CPM en Vanadis, prijs op aanvraag.
 Voor toeslagen en kortingen zie blad 2.

Posaunenhals type P

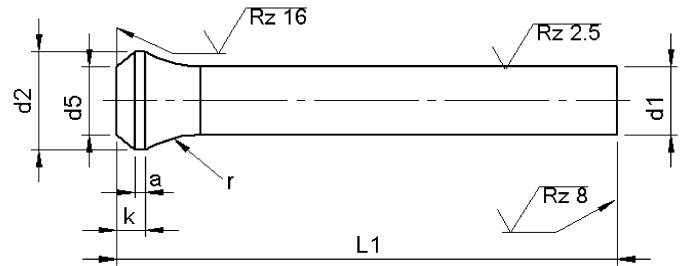
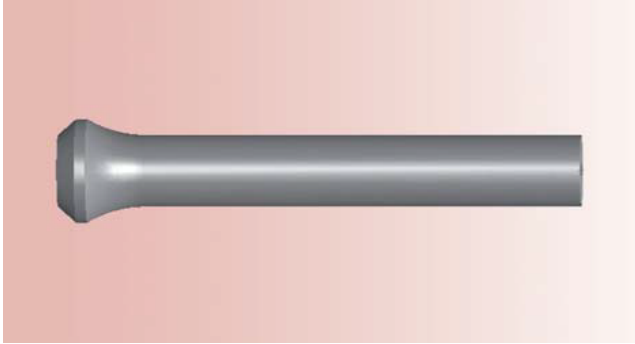

Materiaal: HSS (1.3343)
Hardheid: Schacht: 64 ±2 HRC
Kop: 50 ±5 HRC

d ₁ h ₆	d ₂ 0 -0.2	k +0.2 0	a	d ₅	r 0 -0.2	l ₁ +0.5 0				
						71	80	90	100	120
						Prijs per stuk in EURO				
15,0	19,0	4.0	1.5	d1 ± 0.1	15.0	17,22	18,85	20,83	22,89	27,34
15.5	20.0					17,79	19,47	21,47	23,66	28,37
16,0	20,0					18,31	20,11	22,18	24,37	29,27
16.5	21,0					18,80	20,65	22,76	25,01	30,04
17,0	21,0					19,29	21,27	23,35	25,66	30,82
17.5	22,0					19,78	21,89	23,92	26,31	31,59
18,0	22,0					20,27	22,51	24,50	26,95	31,08
18.5	23,0					20,76	23,12	25,08	27,59	31,85
19,0	23,0					21,25	23,74	25,66	28,25	32,62
19.5	25,0					21,86	24,35	26,24	28,89	33,40
20,0	25,0	22,24	24,44	26,88	29,54	35,53				

Tusseliggende diameter of lengte en andere materialen zoals ASP,CPM en Vanadis, prijs op aanvraag.

Toeslagen en kortingen:

- 1 stuks per afmeting + 50%
- 2-3 stuks per afmeting + 25%
- 25 stuks per afmeting - 5%
- 50 stuks per afmeting - 10%
- 100 stuks per afmeting - 15%

Posaunenhalstype PP

Met ronde aanslijping

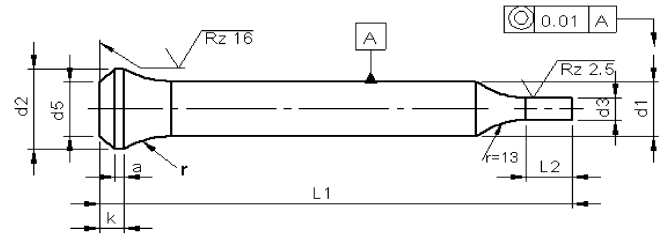
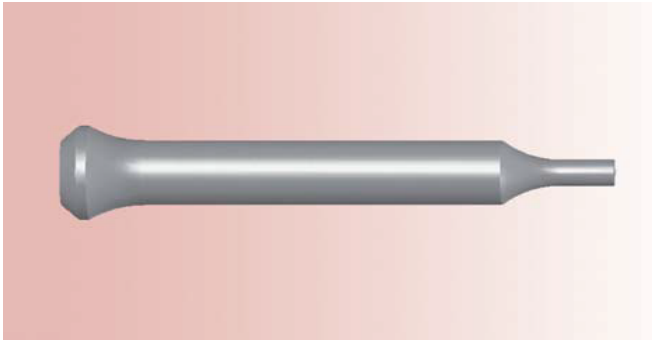

Materiaal: HSS (1.3343)
Hardheid: Schacht: 64 ±2 HRC
Kop: 50 ±5 HRC

d ₁ h6	d ₃ h6		l ₂ +0.5 +0.0	l ₁ +0.5 0								
	≥	≤		71	80	90	100	120				
								Prijs per stuk in EURO				
5,0	2,5	- 4,9	10	10,96	11,74	12,58	13,41	15,41				
5,5	2,5	- 4,4		12,06	12,89	13,80	14,70	16,83				
6,0	3,0	- 5,9		12,64	13,54	14,44	15,47	17,73				
6,5	3,0	- 6,4		13,74	14,64	15,61	16,70	19,02				
7,0	3,5	- 6,9		14,12	15,03	16,06	17,22	19,67				
7,5	3,0	- 7,4		14,51	15,41	16,51	17,73	20,31				
8,0	3,5	- 7,9	13	14,90	15,93	17,02	18,25	20,96				
8,5	4,0	- 8,4		16,24	17,28	18,44	19,73	22,50				
9,0	4,0	- 8,9		16,70	17,73	18,95	20,11	23,14				
9,5	4,5	- 9,4		17,15	18,18	19,47	20,69	23,79				
10,0	5,0	- 9,9		17,53	18,69	19,98	21,40	24,56				
10,5	5,5	- 10,4		18,90	20,19	21,48	22,93	26,22				
11,0	5,5	- 10,9	17	19,41	20,83	22,12	23,62	27,03				
11,5	6,0	- 11,4		19,93	21,48	22,77	24,30	27,85				
12,0	6,0	- 11,9		20,32	22,12	23,41	24,98	28,66				
12,5	7,0	- 12,4		20,90	22,12	24,06	25,67	29,47				
13,0	9,0	- 12,9		21,48	22,96	24,57	26,38	30,31				
13,5	9,0	- 13,4		24,44	25,96	27,60	29,53	33,59				
14,0	9,5	- 13,9		25,02	26,58	28,24	30,31	34,50				
14,5	9,5	- 14,4		25,60	27,20	28,89	31,08	35,40				

Tussentijdse diameter of lengte en andere materialen zoals ASP, CPM en Vanadis, prijs op aanvraag.

- 1 stuks per afmet + 50%
- 2-3 stuks per afmet + 25%
- 25 stuks per afmeting - 5%
- 50 stuks per afmeting - 10%
- 100 stuks per afmeting - 15%

Posaunenhals type PP

Met ronde aansluiting

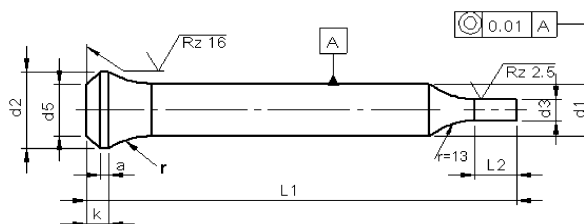
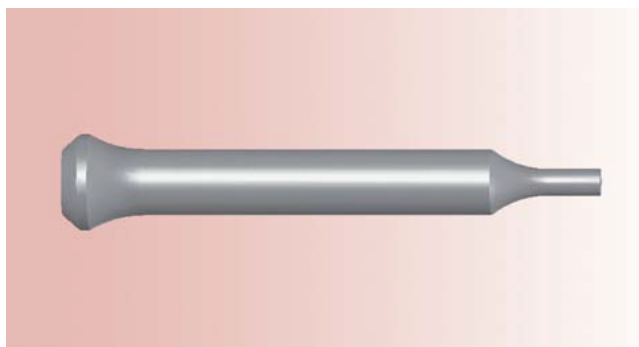

Materiaal: HSS (1.3343)
Hardheid: Schacht: 64 ±2 HRC
 Kop: 50 ±5 HRC

d ₁ h6	d ₃ h8		l ₂ +0.5 +0.0	l ₁ +0.5 0				
	≥	≤		71	80	90	100	120
				Prijs per stuk in EURO				
15,0	10,0	- 14,9	17	26,18	27,82	29,79	31,85	36,30
15,5	10,5	- 15,4		26,76	28,44	30,43	32,63	37,33
16,0	12,0	- 15,9		27,28	29,08	31,14	33,34	38,24
16,5	12,5	- 16,4		31,24	33,09	35,20	37,46	42,49
17,0	13,0	- 16,9		31,73	33,70	35,78	38,10	43,26
17,5	13,0	- 17,4		32,22	34,32	36,36	38,75	44,03
18,0	13,5	- 17,9		32,71	34,94	36,94	39,39	43,52
18,5	13,5	- 18,4		33,20	35,56	37,52	40,04	44,29
19,0	14,0	- 18,9		33,69	36,18	38,10	40,68	45,06
19,5	15,0	- 19,4		33,02	36,80	38,68	41,32	45,84
20,0	16,0	- 19,9		34,68	36,88	39,33	41,97	47,97
25,0	18,0	- 25,9		43,65	46,42	49,45	52,81	56,60

Tussenliggende diameter of lengte en andere materialen zoals ASP, CPM en Vanadis, prijs op aanvraag.

Toeslagen en kortingen:

1 stuks per afmeting	+ 50%
2-3 stuks per afmeting	+ 25%
25 stuks per afmeting	- 5%
50 stuks per afmeting	- 7%
100 stuks per afmeting	- 10%

Posaunenhals type P..

Met standaard profiel



Blad 3.03-1

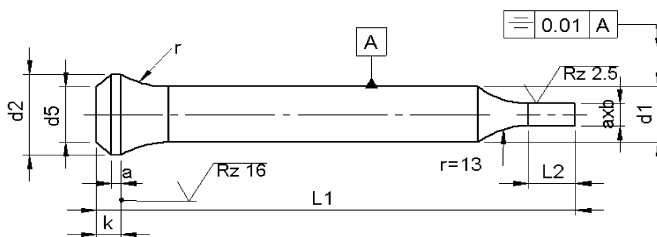
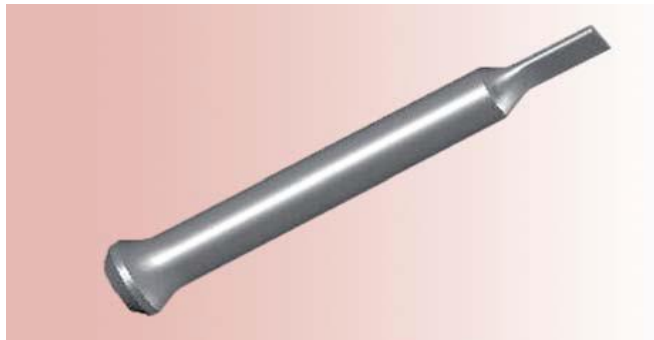

Materiaal: HSS (1.3343)
Hardheid: Schacht: 64 ±2 HRC
Kop: 50 ±5 HRC

Type PF Type PO Type PR Type PS

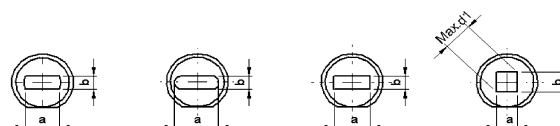

d ₁	AxB ± 0,01		l ₂	l ₁ +0.5 0					Borgvlak
	B	A		71	80	90	100	120	
h ₆	≥	≤		Prijs per stuk in EURO					
5	2,5	4,9	10	27,73	28,50	29,34	30,18	32,18	5,80
5.5	2,5	4,4		28,24	29,08	29,98	30,89	33,01	
6	3,0	5,9		28,82	29,73	30,63	31,66	33,92	
6.5	3,0	6,4		35,98	36,88	37,85	38,94	41,26	
7	3,5	6,9		36,36	37,27	38,30	39,46	41,91	
7.5	3,0	7,4		36,75	37,65	38,75	39,97	42,55	
8	3,5	7,9	13	37,14	38,17	39,26	40,49	43,20	7,75
8.5	4,0	8,4		37,59	38,62	39,78	41,07	43,84	
9	4,0	8,9		38,04	39,07	40,30	41,46	44,49	
9.5	4,5	9,4	38,49	39,52	40,81	42,04	45,13		
10	5,0	9,9	17	38,88	40,04	41,33	42,75	45,91	
10.5	5,5	10,4		39,39	40,68	41,97	43,43	46,72	
11	5,5	10,9		39,91	41,33	42,62	44,11	47,53	
11.5	6,0	11,4		40,43	41,97	43,26	44,80	48,34	
12	6,0	11,9		40,81	42,62	43,91	45,48	49,16	
12.5	7,0	12,4		41,39	42,62	44,55	46,16	49,97	
13	9,0	12,9		41,97	43,46	45,07	46,87	50,81	
13.5	9,0	13,4		42,55	44,07	45,71	47,65	51,71	
14	9,5	13,9		43,13	44,69	46,36	48,42	52,61	
14.5	9,5	14,4		43,71	45,31	47,00	49,19	53,51	

De profielnippel kan tegen meerprijs met borgvlak geleverd worden.
 Standaard wordt het borgvlak evenwijdig aan de a-maat gemaakt.
 Tusseliggende diameter of lengte en andere materialen zoals ASP, CPM en Vanadis, prijs op aanvraag.

Voor toeslagen en kortingen zie blad 2.

Gerimex b.v. Telefoon +31 74 2436655 . info@gerimex.com . www.gerimex.com

Posaunenhals type P..

Met standaard profiel

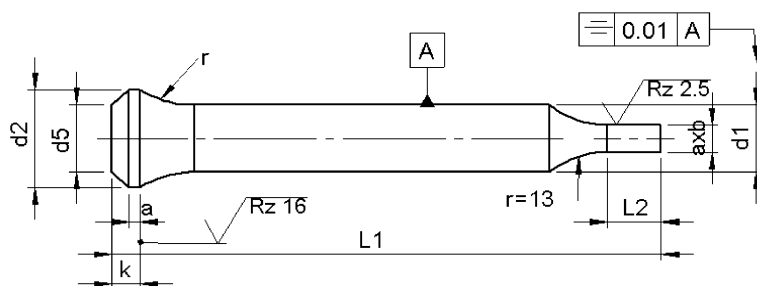
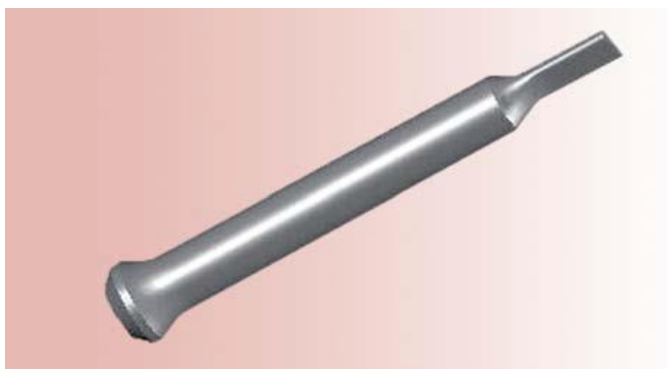

Materiaal: HSS (1.3343)
Hardheid: Schacht: 64 ±2 HRC
Kop: 50 ±5 HRC

Type PF Type PO Type PR Type PS

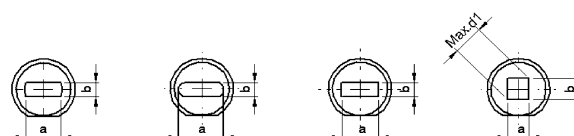

d ₁ h ₆	d ₂	-	AxB ± 0,01		l ₂ +0.5 0	l ₁					Borgvlak
			B ≥	-		A ≤	71	80	90	100	
15	19.0	-	10,0	-	14,9	44,29	45,93	47,90	49,97	54,42	8,15
15.5	20.0	-	10,5	-	15,4	44,87	46,55	48,55	50,74	55,45	
16	20.0	-	12,0	-	15,9	45,39	47,20	49,26	51,45	56,35	
16.5	21.0	-	12,5	-	16,4	59,43	61,27	63,38	65,64	70,67	11,15
17	21.0	-	13,0	-	16,9	59,92	61,89	63,96	66,29	71,44	
17.5	22.0	-	13,0	-	17,4	60,41	62,51	64,54	66,93	72,22	
18	22.0	-	13,5	-	17,9	60,90	63,13	65,13	67,58	71,70	
18.5	23.0	-	13,5	-	18,4	61,39	63,75	65,71	68,22	72,48	
19	23.0	-	14,0	-	18,9	61,88	64,36	66,29	68,86	73,25	
19.5	25.0	-	15,0	-	19,4	62,48	64,98	66,87	69,51	74,02	
20	25.0	-	16,0	-	19,9	62,87	65,06	67,51	70,15	76,15	
25	25.0	-	18,0	-	24,9	74,99	77,76	80,80	84,15	91,55	12,95

De profielnippel kan tegen meerprijs met borgvlak geleverd worden.

Standaard wordt het borgvlak evenwijdig aan de a-maat gemaakt.

Tusseliggende diameter of lengte en andere materialen zoals ASP, CPM en Vanadis, prijs op aanvraag.

Toeslagen en kortingen:

1 stuks per afmeting	+ 50%
2-3 stuks per afmeting	+ 25%
25 stuks per afmeting	- 5%
50 stuks per afmeting	- 7%
100 stuks per afmeting	- 10%

Posaunenhals type EP

Met verende uitwerper

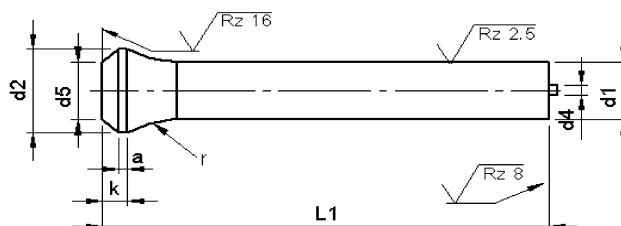
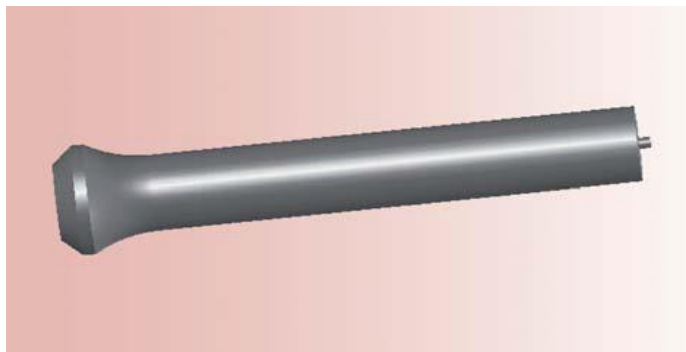

Materiaal: HSS (1.3343)

Hardheid: Schacht: 64 ±2 HRC

Kop: 50 ±5 HRC

d ₁	d ₂	k	a	d ₅	r	d ₄	l ₁				
							71	80	90	100	120
h ₆		+0.2 0	+0.2 0				Prijs per stuk in EURO				
5	9	4	1.5	d1 ± 0.1	10	1	24,65	27,17	29,86	32,85	
6	10						24,95	27,48	30,24	33,23	
8	11				12	1.5	24,86	27,40	30,09	33,16	39,76
10	14						26,94	29,63	32,54	35,84	42,98
13	17				15	2.3	30,63	33,62	37,00	40,68	48,82
16	20						34,69	38,15	41,99	46,21	55,42
20	25						39,38	43,29	47,59	52,35	62,86
25	31								45,50	49,66	53,85

Tussenliggende diameter of lengte en andere materialen zoals ASP, CPM en Vanadis, prijs op aanvraag.

Toeslagen en kortingen:

1 stuks per afmeting + 50%

2-3 stuks per afmeting + 25%

25 stuks per afmeting - 5%

50 stuks per afmeting - 7%

100 stuks per afmeting - 10%

Posaunenhals type EPP

Met ronde aanslijping en uitwerper



Blad 3.05

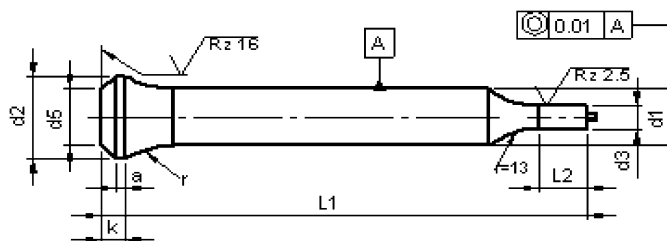

Materiaal: HSS (1.3343)
 Hardheid: Schacht: 64 ±2 HRC
 Kop: 50 ±5 HRC

d ₁	d ₂	d ₃		l ₂	l ₁				
		≥	≤		71	80	90	100	120
5	9	3,0	4,9	10	29,52	32,10	34,99	38,12	
6	10	3,0	5,9		29,73	32,37	35,20	38,27	
8	11	3,5	7,9	13	30,69	33,33	36,15	39,35	46,16
10	14	5,0	9,9	17	33,74	36,56	39,57	43,01	50,44
13	17	9,0	12,9		37,21	43,79	43,58	47,27	55,40
16	20	12,0	15,9		45,07	48,63	52,62	57,04	66,62
20	25	16,0	19,9		53,40	57,45	61,93	66,91	77,84
25	31	18	25,9		61,55	65,71	69,90	74,54	87,26

Tussenliggende diameter of lengte en andere materialen zoals ASP,CPM en Vanadis, prijs op aanvraag.

Toeslagen en kortingen:

- 1 stuks per afmeting + 50%
- 2-3 stuks per afmeting + 25%
- 25 stuks per afmeting - 5%
- 50 stuks per afmeting - 7%
- 100 stuks per afmeting - 10%

Posaunenhals type EP..

Met standaard profiel en uitwerper

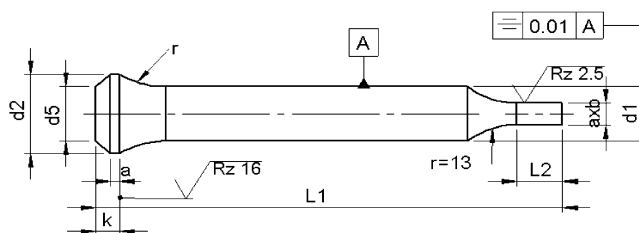
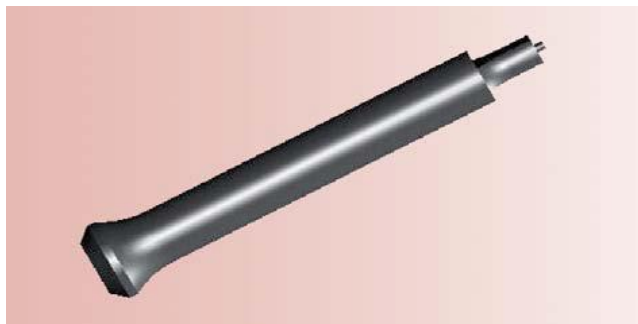

Type EPF Type EPO Type EPR Type EPS

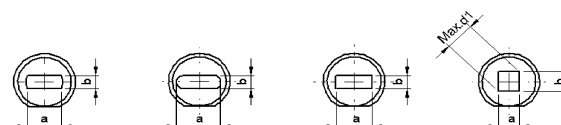

Materiaal: HSS (1.3343)
 Hardheid: Schacht: 64 ±2 HRC
 Kop: 50 ±5 HRC

d ₁	AxB ± 0,01			l ₂ +0.5 0	l ₁					
	B ≥	-	A ≤		63/71	80	90	100	120	Borgvlak
Prijs per stuk in EURO										
5	2.5	-	4.9	10	44,95	47,49	50,17	53,16	0,00	6,10
6	3.0	-	5.9		45,25	47,80	50,56	53,54	0,00	
8	4.0	-	7.9	17	51,95	54,48	57,17	60,24	66,84	8,15
10	5.0	-	9.9		53,91	56,71	59,62	62,93	70,06	
13	9.0	-	12.9		57,71	60,70	64,08	67,77	75,90	
16	12.0	-	15.9		61,77	65,22	69,07	73,29	82,50	
20	16.0	-	19.9		80,00	85,58	90,12	95,09	103,49	
25	18	-	24,9	92,89	97,06	101,24	105,89	118,60	12,95	

De profielnippel kan tegen meerprijs met borgvlak geleverd worden.

Standaard wordt het borgvlak evenwijdig aan de a-maat gemaakt.

Tussentijdse diameter of lengte en andere materialen zoals ASP, CPM en Vanadis, prijs op aanvraag.

Toeslagen en kortingen:

1 stuks per afmeting	+ 50%
2-3 stuks per afmeting	+ 25%
25 stuks per afmeting	- 5%
50 stuks per afmeting	- 7%
100 stuks per afmeting	- 10%

Verzinkfrees
Voor posaunenhal's stempels



Blad 3.07

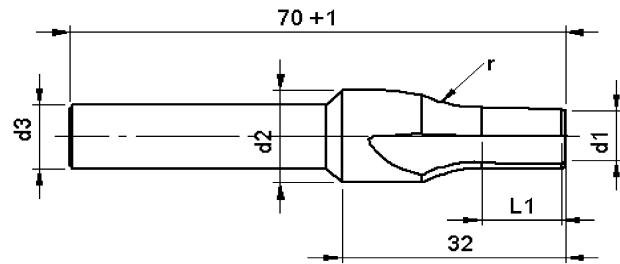
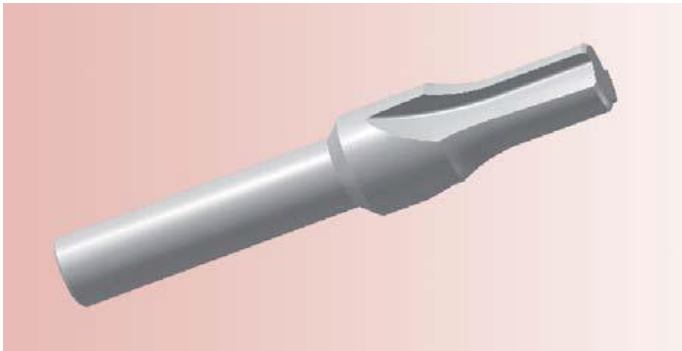

Materiaal: HSS (1.3343)
Hardheid: Schacht: 64 ±2 HRC

d_1 f_7	d_2 h_8	d_3 h_{11}	r $+0.2$ 0	l_1	$X^*(d1)$	Prijs per stuk in EURO
5,0	7,4	=d2	10,0	10,0	0,1	46,05
5,5	8,5					50,97
6,0	9,5					55,88
6,5 - 7,0	10,5	10	12,0	59,56		
7,5 - 8,0	11,5			64,47		
8,5 - 9,0	13,5			74,91		
9,0	5,9			42,37		
4,5-4,9	6,4			46,05		
5,0-5,4	7,4			46,05		
5,5-5,9	8,5	50,97	0,5			
6,0	9,5	55,88				
6,5-7,0	10,5	59,56				
7,5-8,0	11,5	64,47				
8,5-9,0	13,5	74,91				
9,5 - 10,0	14,5	79,83				
10,5 - 11,0	15,5	79,83				
11,5 - 12,0	16,5	79,83				
12,5 - 13,0	17,5	97,02				
13,5 - 14,0	18,5	97,02				
14,5 - 15,0	19,5	97,02				
15,5 - 16,0	20,5	97,02				
16,5 - 17,0	21,5	16,0	15,0	109,30		
17,5 - 18,0	22,5			109,30		
18,5 - 19,0	23,5			109,30		
19,5 - 20,0	25,5			109,30		
25,0	30,5			116,67		

30° kop nippel

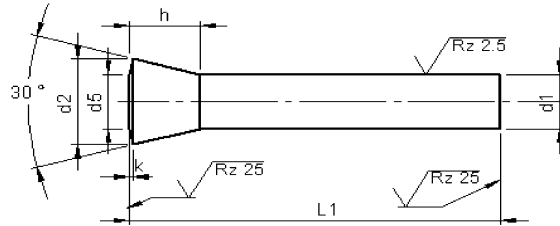
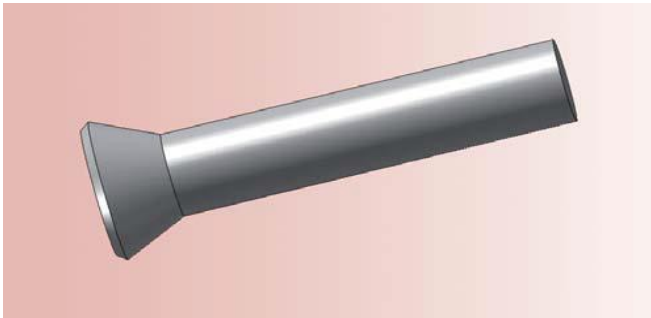

Materiaal: HSS (1.3343)
Hardheid: Schacht: 64 ±2 HRC
Kop: 50 ±5 HRC

d ₁	d ₂ 0 -0.3	d ₅	h	k	l ₁ +1.0 0				
					71	80	90	100	120
Prijs per stuk in EURO									
4	6.6	3.8	6	1	7,41	8,12	9,28	10,38	
5	8.2	5	7	1	7,41	8,19	9,03	9,86	11,86
6	9.7	6	8	1	8,51	9,41	10,32	11,35	13,60
7	11.8	7	10	1	10,06	11,09	12,19	13,41	16,12
8	12.8	8	10	1	11,80	12,96	14,25	15,67	18,83
9	14.4	9	11	1	13,35	14,51	15,80	17,21	20,37
10	15.9	10	12	1	14,89	16,38	17,99	19,79	23,73
11	17.4	11	13	1.5	16,57	18,05	18,38	21,47	25,40
12	18.7	12	14	1.5	18,31	20,12	22,18	24,37	29,27
13	20.2	13	15	1.5	19,60	21,41	23,47	25,66	30,56
14	21.8	14	16	1.5	20,95	22,89	24,76	26,95	31,85
15	23.3	15	17	1.5	22,24	24,44	26,89	29,53	35,53
16	24.6	16	18	2	23,53	25,73	28,17	30,82	36,81

Toeslagen en kortingen:

1 stuks per afmeting	+ 50%
2-3 stuks per afmeting	+ 25%
25 stuks per afmeting	- 5%
50 stuks per afmeting	- 7%
100 stuks per afmeting	- 10%

30° kop nippel

Met ronde aanslijping



Blad 4.02

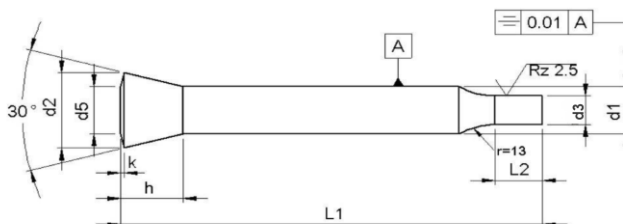
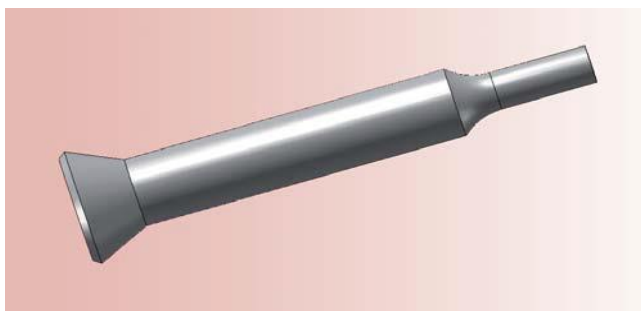

Materiaal: HSS (1.3343)
Hardheid: Schacht: 64 ±2 HRC
Kop: 50 ±5 HRC

d ₁	d ₃ h ₆			l ₂ +0,5 0,0	l ₁ +1.0 0				
					71	80	90	100	120
h ₆	≥	-	≤	Prijs per stuk in EURO					
4	1,6	-	3,9	10	10,64	11,35	12,51	13,60	
5	2,5	-	4,9	10	10,96	11,73	12,57	13,41	15,41
6	3,0	-	5,9	10	12,64	13,54	14,44	15,47	17,73
7	3,0	-	6,9	10	14,89	15,93	17,02	18,25	20,95
8	4,0	-	7,9	13	16,63	17,79	19,08	20,50	23,66
9	4,5	-	8,9	13	19,08	20,24	21,53	22,95	26,11
10	5,0	-	9,9	17	20,63	22,11	23,73	25,73	29,46
11	5,0	-	10,9	17	23,15	24,50	24,95	28,05	31,85
12	6,0	-	11,9	17	24,89	26,69	28,76	30,95	35,85
13	9,0	-	12,9	17	26,18	27,98	30,05	32,24	37,14
14	9,5	-	13,9	17	29,92	31,85	33,72	35,91	40,81
15	10,0	-	14,9	17	31,21	33,40	35,85	38,49	44,49
16	12,0	-	15,9	17	32,50	34,68	37,13	39,78	45,78

Tussenliggende diameter of lengte en andere materialen zoals ASP, CPM en Vanadis, prijs op aanvraag.

Toeslagen en kortingen:

- 1 stuks per afmeting + 50%
- 2-3 stuks per afmeting + 25%
- 25 stuks per afmeting - 5%
- 50 stuks per afmeting - 7%
- 100 stuks per afmeting - 10%

Gerimex b.v. Telefoon +31 74 2436655 . info@gerimex.com . www.gerimex.com

30° kop nippel

Met standaard profielaanslijping

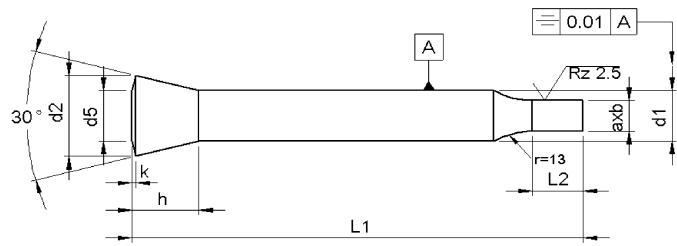
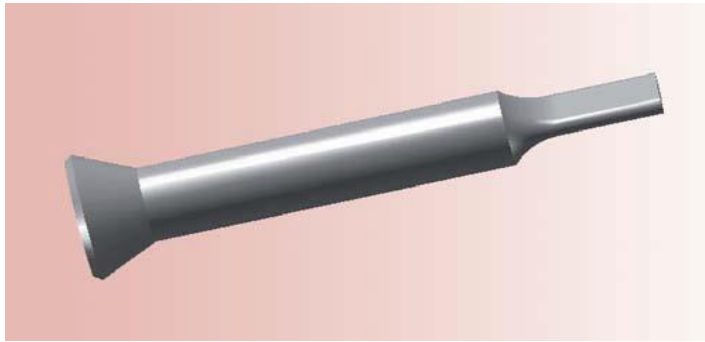

Materiaal: HSS (1.3343)
Hardheid: Schacht: 64 ±2 HRC
Kop: 50 ±5 HRC

Type 30°F

Type 30°O

Type 30°R

Type 30°S

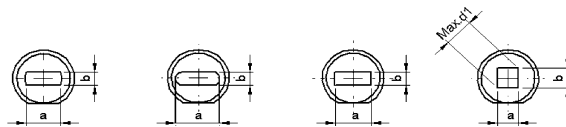

d ₁	AxB ± 0.01		l ₂	l ₁ +1 0					
	B ≥	A ≤		71	80	90	100	120	Borgvlak
h ₆			+0,5 0	Prijs per stuk in EURO					
4	1,6	3,9	10	27,72	28,43	29,60	30,70		6,10
5	2,5	4,9		27,72	28,50	29,33	30,17	32,18	
6	3,0	5,9		28,82	29,73	30,63	31,65	33,92	
7	3,0	6,9		30,37	31,40	32,49	33,72	36,42	
8	4,0	7,9	13	38,87	40,04	41,33	42,75	45,91	8,15
9	4,5	8,9		40,43	41,58	42,88	44,30	47,45	
10	5,0	9,9	17	41,98	43,46	45,07	46,88	50,81	
11	5,0	10,9		43,65	45,13	45,45	48,55	52,48	
12	6,0	11,9		45,40	47,19	49,26	51,45	56,35	
13	9,0	12,9		46,68	48,49	50,55	52,75	57,65	
14	9,5	13,9		48,03	49,97	51,84	54,66	58,93	
15	10,0	14,9		49,33	51,52	53,97	56,61	62,60	
16	12,0	15,9		50,61	52,80	55,25	57,90	63,90	

De profielnippel kan tegen meerprijs met borgvlak geleverd worden.

Standaard wordt het borgvlak evenwijdig aan de a-maat gemaakt.

Tussenliggende diameter of lengte en andere materialen zoals ASP, CPM en Vanadis, prijs op aanvraag.

Toeslagen en kortingen:

1 stuks per afmeting	+ 50 %
2-3 stuks per afmeting	+ 25 %
25 stuks per afmeting	- 5 %
50 stuks per afmeting	- 7 %
100 stuks per afmeting	- 10 %

Gerimex b.v. Telefoon +31 74 2436655 . info@gerimex.com . www.gerimex.com

Snelwisselnippel type BT (Light Duty)

Snelwisselnippel type BHT (Heavy Duty)



Blad 5.01

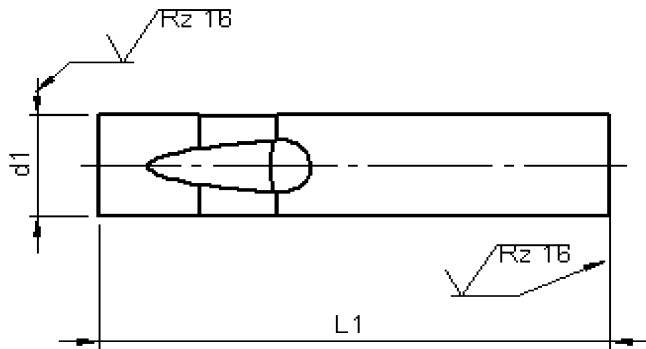
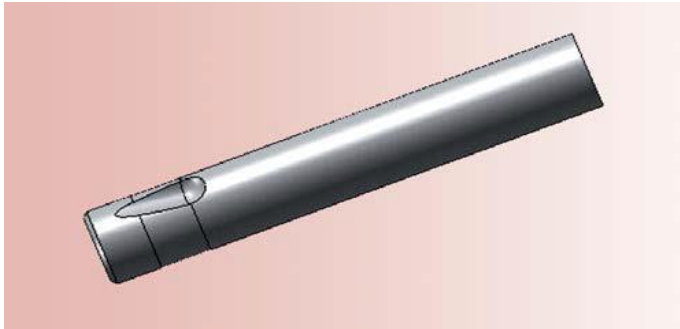

Materiaal: HSS (1.3343)

Hardheid: Schacht: 64 ±2 HRC

Kop: 50 ±5 HRC

d ₁ g _s	l ₁ +0,3 +0,1				
	63/71	80	90	100	125
	Prijs per stuk in EURO				
6	10,06	10,83	11,73	12,77	14,83
10	13,15	14,18	15,54	16,83	19,86
13	16,12	17,41	19,02	20,76	24,50
16	19,34	21,15	23,02	25,14	29,66
20	23,08	25,14	27,53	30,11	35,65
25	28,18	30,82	33,72	36,88	43,84

Tussenliggende diameter of lengte en andere materialen zoals ASP, CPM en Vanadis, prijs op aanvraag.

Toeslagen en kortingen:

1 stuks per afmeting	+ 50 %
2-3 stuks per afmeting	+ 25 %
25 stuks per afmeting	- 5 %
50 stuks per afmeting	- 7 %
100 stuks per afmeting	- 10 %

Snelwisselnippel type BTP (Light Duty) Snelwisselnippel type BHTP (Heavy Duty)

Met ronde aanslijping

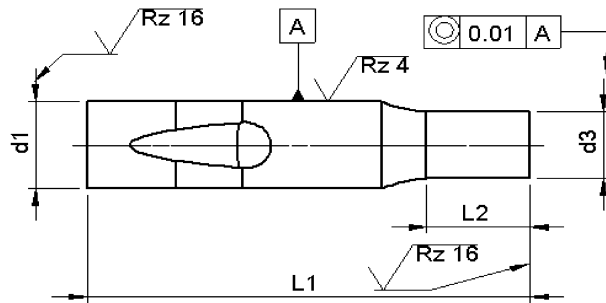
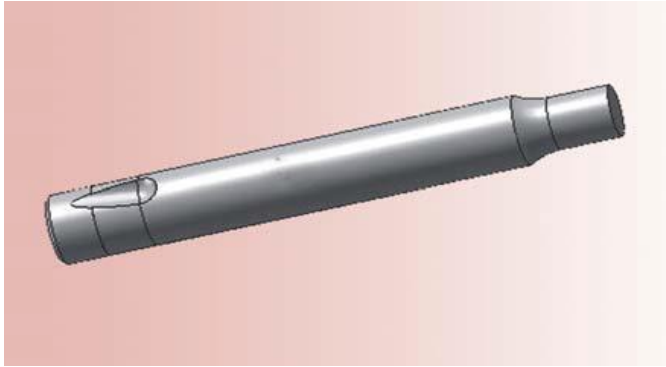

Materiaal: HSS (1.3343)
Hardheid: Schacht: 64 ±2 HRC
Kop: 50 ±5 HRC

d ₁ g ₅	d ₃ +0.01 0		l ₂ +0,5 0	l ₁ +0.3 +0.2					
	≥	-		≤	63/71	80	93	100	125
Prijs per stuk in EURO									
6	3,0	-	5,9	10	14,18	14,96	15,86	16,89	18,95
10	5,0	-	9,9	17	18,89	19,92	21,27	22,56	25,59
13	9,0	-	12,9	17	22,69	23,98	25,59	27,33	31,07
16	12,0	-	15,9	17	28,30	30,11	31,98	34,10	38,62
20	16,0	-	19,9	17	35,52	37,58	39,97	42,55	48,09
25	20,0	-	24,9	17	44,22	46,87	49,77	52,93	59,89

Tussenliggende diameter of lengte en andere materialen zoals ASP, CPM en Vanadis, prijs op aanvraag.

Toeslagen en kortingen:

1 stuks per afmeting	+ 50 %
2-3 stuks per afmeting	+ 25 %
25 stuks per afmeting	- 5 %
50 stuks per afmeting	- 7 %
100 stuks per afmeting	- 10 %

Snelwisselnippel type BT (Light Duty)
Snelwisselnippel type BHT (Heavy Duty)
 Met standaard profielaanslijping



Blad 5.03

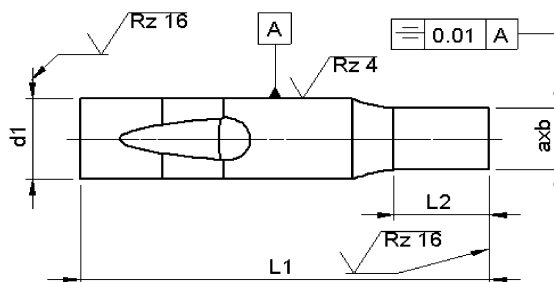
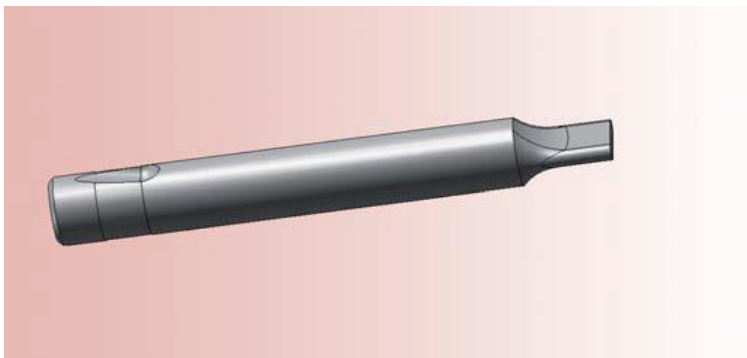

type BTF type BTO type BTR type BTS

Materiaal: HSS (1.3343)
Hardheid: Schacht: 64 ±2 HRC
Kop: 50 ±5 HRC

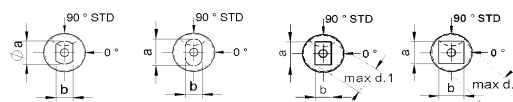

d ₁	AxB ± 0.01		l ₂ +0.5 0	l ₁ +0.2 +0.1					
	B ≥	A ≤		63/71	80	93	100	125	
g ₅	Prijs per stuk in EURO								
6	3,0	-	5,9	10	30,36	31,14	32,04	33,07	35,13
10	5,0	-	9,9	17	40,23	41,26	43,19	43,90	46,93
13	9,0	-	12,9	17	43,19	44,48	46,09	47,83	51,57
16	12,0	-	15,9	17	46,42	48,22	50,09	52,22	56,73
20	16,0	-	19,9	17	63,69	65,76	68,14	70,72	76,26
25	20,0	-	24,9	17	75,56	78,20	81,10	84,26	91,22

Tussenliggende diameter of lengte en andere materialen zoals ASP, CPM en Vanadis, prijs op aanvraag.
 Standaard zit de kogelzitting aan de korte zijde van het profiel (90°)

Toeslagen en kortingen:

- 1 stuks per afmeting + 50%
- 2-3 stuks per afmeting + 25%
- 25 stuks per afmeting - 5%
- 50 stuks per afmeting - 7%
- 100 stuks per afmeting - 10%

Snelwisselnippel type EBT (Light Duty)
Snelwisselnippel type EBHT (Heavy Duty)
 Inclusief verende uitwerpen

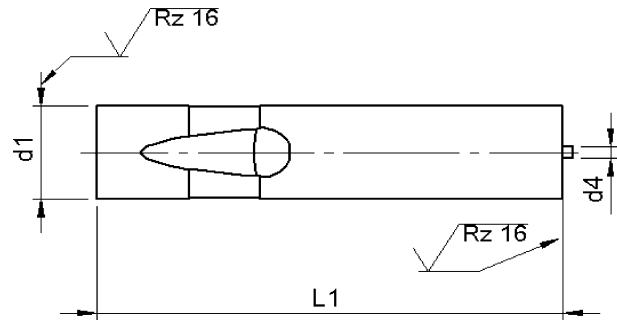
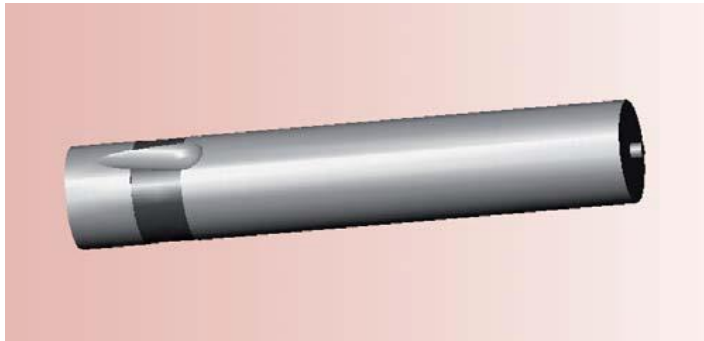

Materiaal: HSS (1.3343)
Schacht: 64 ±2 HRC
Kop: 50 ±5 HRC

d ₁ g ₅	l ₁				
	63/71	80	93	100	125
	Prijs per stuk in EURO				
6	22,95	23,73	24,63	25,66	27,72
10	26,05	27,08	28,43	29,72	32,75
13	29,01	30,30	31,91	33,66	37,40
16	32,24	34,04	35,91	38,04	42,55
20	35,98	38,04	40,43	43,00	48,55
25	41,07	43,71	46,61	49,77	56,74

Tussentijdse diameter of lengte en andere materialen zoals ASP, CPM en Vanadis, prijs op aanvraag.

Toeslagen en kortingen:

- 1 stuks per afmeting + 50%
- 2-3 stuks per afmeting + 25%
- 25 stuks per afmeting - 5%
- 50 stuks per afmeting - 7%
- 100 stuks per afmeting - 10%

Snelwisselnippel type EBTP (Light Duty)
Snelwisselnippel type EBHTP (Heavy Duty)
 Inclusief verende uitwerpen met ronde aanslijping



Blad 5.05

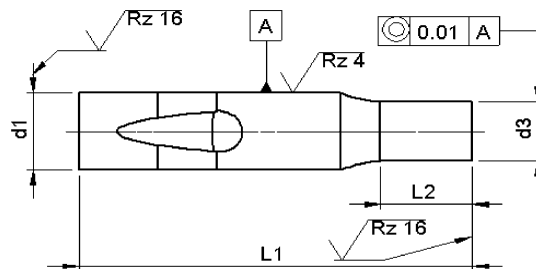
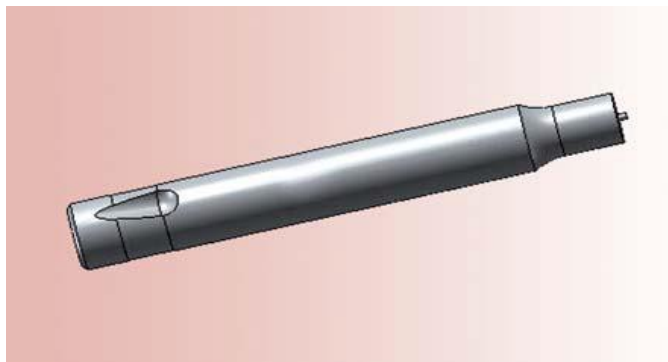

Materiaal: HSS (1.3343)
Hardheid: Schacht: 64 ±2 HRC
Kop: 50 ±5 HRC

d ₁	d ₃ +0.01 0		l ₂ +0.5 0	l ₁ +0.3 +0.2				
				63/71	80	93	100	125
g ₆	≥	≤		Prijs per stuk in EURO				
6	3,0	– 5,9	10	27,08	27,85	28,76	30,05	31,85
10	5,0	– 9,9	17	31,79	32,82	34,17	35,46	38,49
13	9,0	– 12,9	17	35,59	36,88	38,49	41,52	43,97
16	12,0	– 15,9	17	42,49	43,00	44,87	47,00	51,51
20	16,0	– 19,9	17	61,32	50,48	52,87	55,45	60,99
25	20,0	– 24,9	17	68,78	59,77	62,67	65,83	72,79

Tussentijdse diameter of lengte en andere materialen zoals ASP, CPM en Vanadis, prijs op aanvraag.

Toeslagen en kortingen:

1 stuks per afmeting	+ 50%
2-3 stuks per afmeting	+ 25%
25 stuks per afmeting	– 5%
50 stuks per afmeting	– 7%
100 stuks per afmeting	– 10%

Snelwisselnippel type EBTP (Light Duty)
Snelwisselnippel type EBHTP (Heavy Duty)
 Inclusief verende uitwerpen met profiel aanslijping

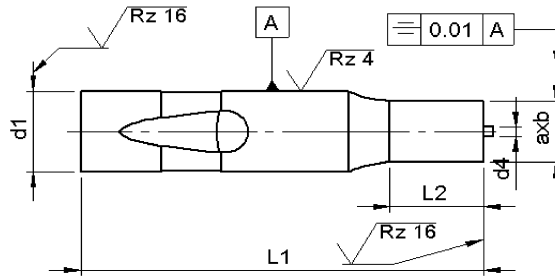
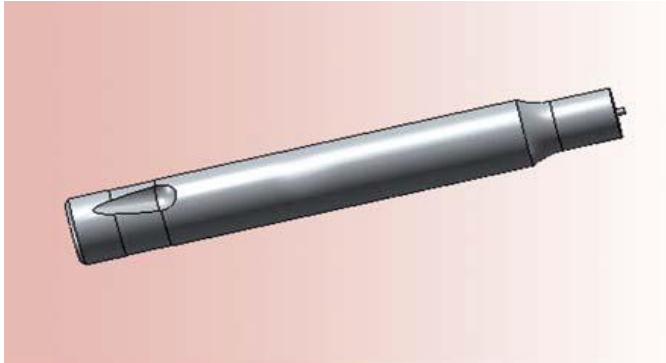

type EBTF type EBTO type EBTR type EBTS

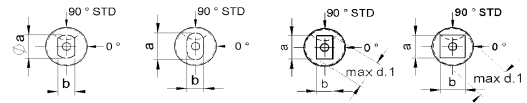

Materiaal: HSS (1.3343)
Schacht: 64 ±2 HRC
Kop: 50 ±5 HRC

d ₁ g ₅	AxB		l ₂	l ₁				
	+0.01 0			+0.2 +0.1				
	B	A		63/71	80	93	100	125
	≥	≤		Prijs per stuk in EURO				
6	3,0	5,9	10	43,26	44,03	44,93	45,97	48,03
10	5,0	9,9	17	53,12	54,15	56,09	56,80	59,83
13	9,0	12,9	17	56,09	57,38	58,99	60,73	64,47
16	12,0	15,9	17	59,31	61,11	62,98	65,11	69,62
20	16,0	19,9	17	76,59	78,65	81,04	83,61	89,16
25	20,0	24,9	17	88,45	91,09	93,99	97,15	104,11

Tussenliggende diameter of lengte en andere materialen zoals ASP, CPM en Vanadis, prijs op aanvraag.
 Standaard zit de kogelzitting aan de korte zijde van het profiel (90°)

Toeslagen en kortingen:

- 1 stuks per afmeting + 50%
- 2-3 stuks per afmeting + 25%
- 25 stuks per afmeting - 5%
- 50 stuks per afmeting - 7%
- 100 stuks per afmeting - 10%

Snijbussen DIN 9845 A / B



Blad 6.01

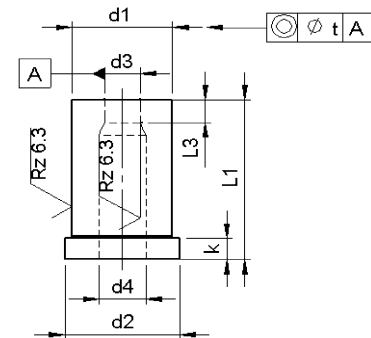
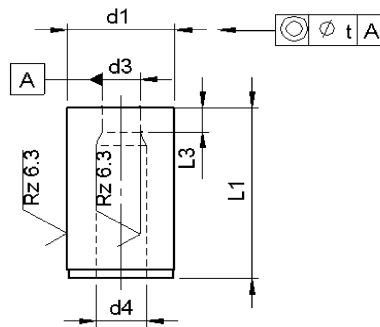
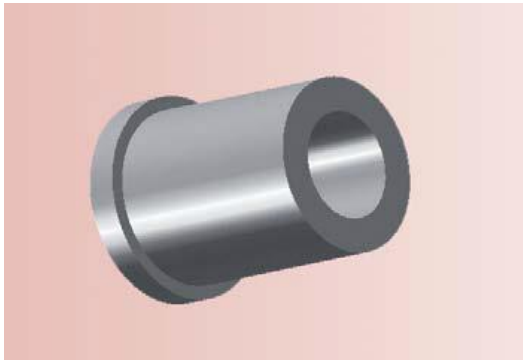

Materiaal: HSS (1.3343)
Hardheid: Schacht: 64 ±2 HRC

d ₁	d ₂	k	d ₃ H ₈ van t/m			l ₃	d ₄ ± 0.1	Form A		Form B	
								l ₁	l ₁	l ₁	l ₁
Type A n6	Type B k6						20	28	20	28	
							Prijs per stuk in EURO				
5	7	4		1.0	2.0	d ₃ + 0,3	22,00		26,46		
6	8		1.0	2.0	3.0	d ₃ + 0.3	15,07	19,37	17,64	23,42	
7	9		2.1	3.0	3.0	d ₃ + 0.5	12,55	15,70	17,64	18,90	
8	10		3.1	4.0	3.0	d ₃ + 0.5	12,55	14,60	17,64	18,90	
10	12		4.1	5.0	4.0	d ₃ + 0.7	12,55	14,60	17,64	18,90	
12	14		5.1	6.0	4.0	d ₃ + 0.7	12,55	14,60	17,64	18,90	
15	17		6.1	8.0	4.0	d ₃ + 0.7	12,55	16,96	16,33	20,42	
18	20		8.1	10.0	4.0	d ₃ + 1,0	12,55	17,90	17,96	21,68	
22	24		10.1	12.0	5.0	d ₃ + 1,0	15,38	17,90	18,53	22,84	
26	28		12.1	15.0	5.0	d ₃ + 1,0	20,42	24,68	24,73	29,87	
30	32		15.1	18.0	5.0	d ₃ + 1,0		30,66		37,64	

Tussenliggende diameter of lengte en andere materialen zoals ASP, CPM en Vanadis, prijs op aanvraag.

Geleidebus DIN 9845 C

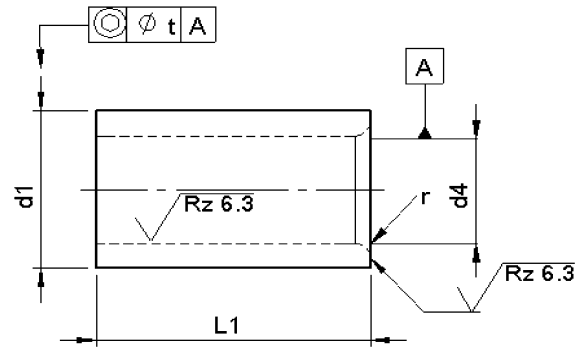

Materiaal: HWS (1.2379)
Hardheid: Schacht: 64 ±2 HRC

\geq	d_4 H_7	\leq	d_1 n_6	l_1	r	t	d_4	Prijs per stuk in EURO
		1.0	5	9	1.0	0.01	0.10	14,96
1.1		2.0	6	12	1.0	0.01	0.10	13,91
2.1		3.0	7	12	1.0	0.01	0.10	18,01
3.1		4.0	8	12	1.0	0.01	0.10	11,34
4.1		5.0	10	16	1.0	0.01	0.10	7,82
5.1		6.0	12	16	1.5	0.01	0.10	8,72
6.1		8.0	15	20	1.5	0.01	0.10	10,70
8.1		10.0	18	20	2.0	0.01	0.10	13,60
10.1		12.0	22	28	2.0	0.01	0.10	13,60
12.1		15.0	26	28	2.0	0.01	0.10	16,43
15.5		18.0	30	36	2.0	0.01	0.50	27,25

Snijbussen ISO 8977 A



Blad 6.07

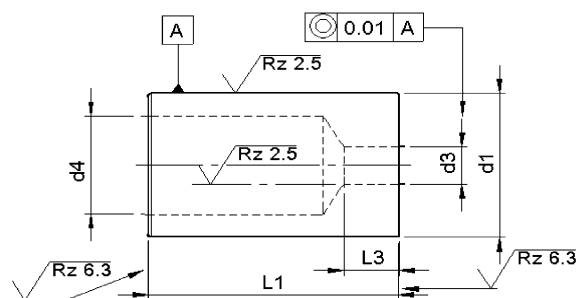
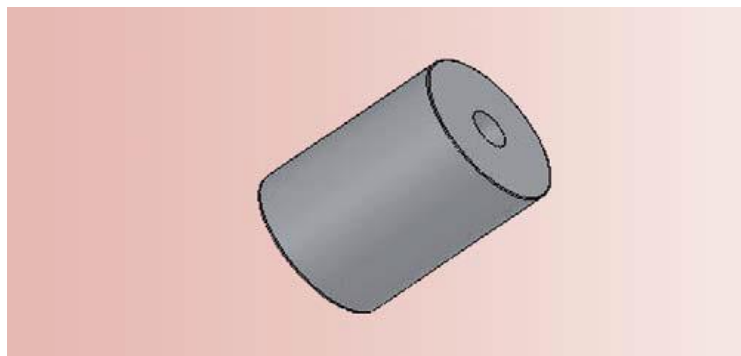

Materiaal: HSS (1.3343)
Hardheid: Schacht: 64 ±2 HRC

d ₁ n ₅	l ₃	d ₃ +0.02 0			d ₄	l ₁ +0,5 0							
		≥	-	≤		16	20	22	25	28	30	32	35
Prijs per stuk in EURO													
5	2	1,0	-	2,4	2,8	17,50	17,73	17,97	18,20	18,43	18,67	18,90	19,13
6	3	1,6	-	3,0	3,5	17,50	17,73	17,97	18,20	18,43	18,67	18,90	19,13
8	4	2,0	-	3,5	4,0	17,50	17,73	17,97	18,20	18,43	18,67	18,90	19,13
10	4	2,5	-	5,0	5,8	18,20	18,43	18,67	18,90	19,13	19,37	19,60	19,83
13	5	3,0	-	7,0	8,0		19,19	19,43	19,66	19,89	20,13	20,36	20,59
16	5	4,0	-	9,0	9,5		19,89	20,13	20,36	20,59	20,83	21,06	21,29
20	8	6,0	-	11,0	12,0		20,59	20,83	21,06	21,29	21,53	21,76	21,99
22	8	8,0	-	11,0	15,0		21,58	21,82	22,05	22,28	22,52	22,75	22,98
25	8	8,0	-	16,0	17,3		22,93	23,16	23,39	23,63	23,86	24,09	24,33
32	8	8,0	-	20,0	20,7		31,56	31,79	32,03	32,26	32,49	32,73	32,96
40	8	19	-	27,0	27,7		49,93	50,17	50,40	50,63	50,87	51,10	51,33
50	8	26	-	36,0	37,0		59,97	60,20	60,43	60,67	60,90	61,13	61,37

Tussenliggende diameter of lengte en andere materialen zoals ASP, CPM en Vanadis, prijs op aanvraag.

Toeslagen en kortingen:

- 1 stuks per afmeting + 50%
- 2-3 stuks per afmeting + 25%
- 25 stuks per afmeting - 5%
- 50 stuks per afmeting - 7%
- 100 stuks per afmeting - 10%

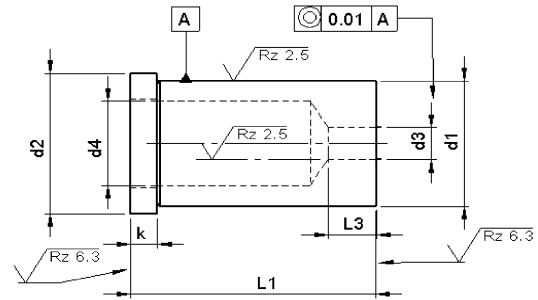
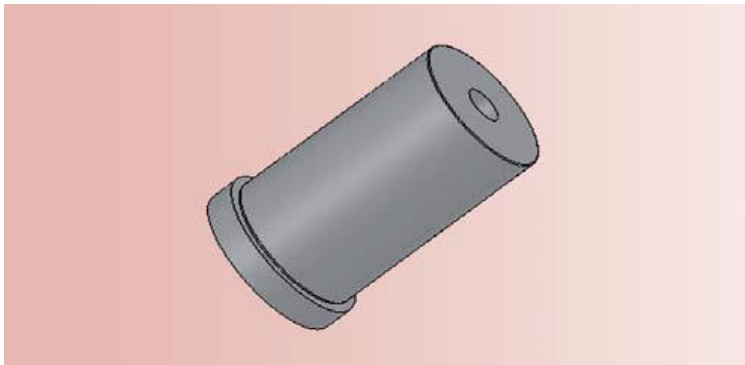

**Materiaal: HSS (1.3343)
Hardheid: Schacht: 64 ±2 HRC**

d ₁ m ₅	d ₂	l ₃	d ₃ +0.02 0 - ≤	d ₄	k +0.25 0	l ₁ +0.5 0							
						16	20	22	25	28	30	32	35
Prijs per stuk in EURO													
5	8	2	1,0 - 2,4	2,8	5	19,83	20,07	20,30	20,53	20,77	21,00	21,23	21,47
6	9	3	1,6 - 3,0	3,5		19,83	20,07	20,30	20,53	20,77	21,00	21,23	21,47
8	11	4	2,0 - 3,5	4,0		19,83	20,07	20,30	20,53	20,77	21,00	21,23	21,47
10	13	4	2,5 - 5,0	5,8		20,53	20,77	21,00	21,23	21,47	21,70	21,93	22,17
13	16	5	3,0 - 7,0	8,0			21,53	21,76	21,99	22,23	22,46	22,69	22,93
16	19	5	4,0 - 9,0	9,5			22,23	22,46	22,69	22,93	23,16	23,39	23,63
20	23	8	6,0 - 11,0	12,0			22,93	23,16	23,39	23,63	23,86	24,09	24,33
22	25	8	8,0 - 14,0	15,0			23,92	24,15	24,38	24,62	24,85	25,08	25,32
25	28	8	8,0 - 16,0	17,3			25,26	25,49	25,73	25,96	26,19	26,43	26,66
32	35	8	8,0 - 20,0	20,7			33,89	34,13	34,36	34,59	34,83	35,06	35,29
40	43	8	19 - 27,0	27,7			52,27	52,50	52,73	52,97	53,20	53,43	53,67
50	53	8	26 - 36,0	37,0			62,30	62,53	62,77	63,00	63,23	63,47	63,70

Tussenliggende diameter of lengte en andere materialen zoals ASP, CPM en Vanadis, prijs op aanvraag.

Toeslagen en kortingen:

- 1 stuks per afmeting + 50%
- 2-3 stuks per afmeting + 25%
- 25 stuks per afmeting - 5%
- 50 stuks per afmeting - 7%
- 100 stuks per afmeting - 10%

Snijbussen ISO 8977 A..

Met standaard profielvormen



Blad 6.09

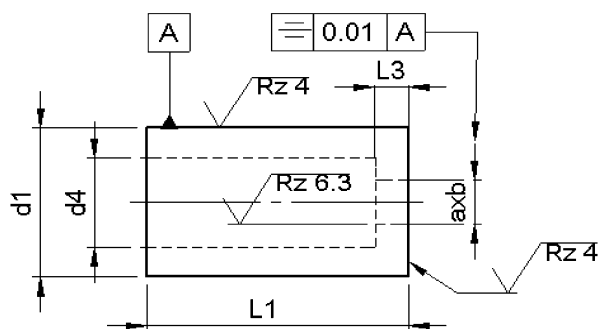
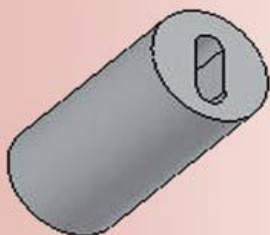

Materiaal: HSS (1.3343)

Hardheid: Schacht: 64 ±2 HRC

d ₁	l ₃	AxB ± 0.01		d ₄	l ₁ +0.5 0								Borgvlak	
		B ≥	A ≤		16	20	22	25	28	30	32	35		
n ₅					Prijs per stuk in EURO									
5	2	1,0	2,4	2,8	18,90	18,90	18,90	18,90	18,90	18,90	18,90	18,90	18,90	6,10
6	3	1,6	3,0	3,5	18,90	18,90	18,90	18,90	18,90	18,90	18,90	18,90	18,90	
8	4	2,0	3,5	4,0	18,90	18,90	18,90	18,90	18,90	18,90	18,90	18,90	18,90	8,15
10	4	2,5	5,0	5,8	18,90	18,90	18,90	18,90	18,90	18,90	18,90	18,90	18,90	
13	5	3,0	7,0	8,0		18,90	18,90	18,90	18,90	18,90	18,90	18,90	18,90	
16	5	4,0	9,0	9,5		22,05	22,05	22,05	22,05	22,05	22,05	22,05	22,05	11,15
20	8	6,0	11,0	12,0		38,85	38,85	38,85	38,85	38,85	38,85	38,85	38,85	
22	8	8,0	11,0	15,0		45,50	45,50	45,50	45,50	45,50	45,50	45,50	45,50	12,95
25	8	8,0	16,0	17,3		52,50	52,50	52,50	52,50	52,50	52,50	52,50	52,50	
32	8	8,0	20,0	20,7		64,05	64,05	64,05	64,05	64,05	64,05	64,05	64,05	14,70
40	8	19	27,0	27,7			100,80	100,80	100,80	100,80	100,80	100,80	100,80	
50	8	26	36,0	37,0				131,25	131,25	131,25	131,25	131,25	131,25	18,90

Standaard wordt het borgvlak evenwijdig aan de a-maat gemaakt. Deze kan echter zonder meerprijs aan de b-maat geleverd worden.

Tussenvliegende diameter of lengte en andere materialen zoals ASP, CPM en Vanadis, prijs op aanvraag.

Toeslagen en kortingen:

- 1 stuks per afmeting + 50%
- 2-3 stuks per afmeting + 25%
- 25 stuks per afmeting - 5%
- 50 stuks per afmeting - 7%
- 100 stuks per afmeting - 10%

Snijbussen ISO 8977 B.. Met standaard profielvormen



Blad 6.10

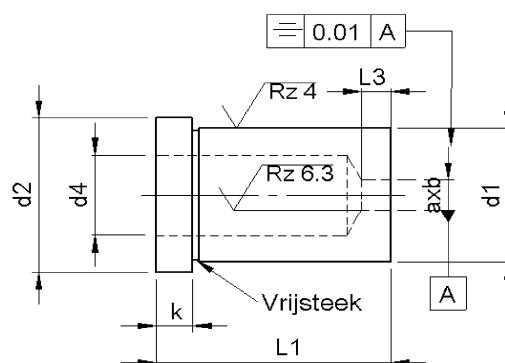
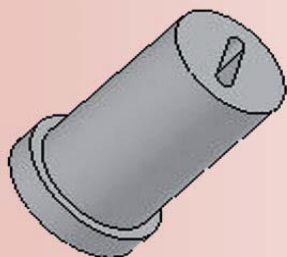

type 8979B F type 8979B O type 8979B R type 8979B S

Materiaal: HSS (1.3343)
Hardheid: Schacht: 64 ±2 HRC

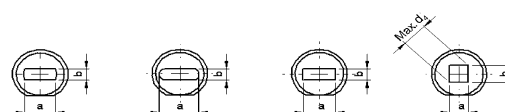

d ₁	d ₂	l ₃	AxB ± 0,01		d ₄	k	l ₁ +0.5 0								Borgvlak ½ d ± 0.01		
			B ≥	A ≤			16	20	22	25	28	30	32	35			
m ₅						+0.25 0	Prijs per stuk in EURO										
5	8	2	1,0	- 2,4	2,8	5	21,00	21,00	21,00	21,00	21,00	21,00	21,00	21,00	21,00	21,00	6,10
6	9	3	1,6	- 3,0	3,5		21,00	21,00	21,00	21,00	21,00	21,00	21,00	21,00	21,00	21,00	
8	11	4	2,0	- 3,5	4,0		21,00	21,00	21,00	21,00	21,00	21,00	21,00	21,00	21,00	21,00	8,15
10	13	4	2,5	- 5,0	5,8		21,00	21,00	21,00	21,00	21,00	21,00	21,00	21,00	21,00	21,00	
13	16	5	3,0	- 7,0	8,0			21,00	21,00	21,00	21,00	21,00	21,00	21,00	21,00	21,00	11,15
16	19	5	4,0	- 9,0	9,5			24,50	24,50	24,50	24,50	24,50	24,50	24,50	24,50	24,50	
20	23	8	6,0	- 11,0	12,0			43,17	43,17	43,17	43,17	43,17	43,17	43,17	43,17	43,17	14,70
22	25	8	8,0	- 14,0	15,0			51,33	51,33	51,33	51,33	51,33	51,33	51,33	51,33	51,33	
25	28	8	8,0	- 16,0	17,3			58,33	58,33	58,33	58,33	58,33	58,33	58,33	58,33	58,33	12,95
32	35	8	8,0	- 20,0	20,7			71,17	71,17	71,17	71,17	71,17	71,17	71,17	71,17	71,17	
40	43	8	19	- 27,0	27,7			112,00	112,00	112,00	112,00	112,00	112,00	112,00	112,00	112,00	15,75
50	53	8	26	- 36,0	37,0			145,83	145,83	145,83	145,83	145,83	145,83	145,83	145,83	145,83	

Standaard wordt het borgvlak evenwijdig aan de a-maat gemaakt. Deze kan echter zonder meerprijs aan de b-maat geleverd worden.

Tussenvliegende diameter of lengte en andere materialen zoals ASP, CPM en Vanadis, prijs op aanvraag.

Toeslagen en kortingen:

1 stuks per afmeting	+ 50%
2-3 stuks per afmeting	+ 25%
25 stuks per afmeting	- 5%
50 stuks per afmeting	- 7%
100 stuks per afmeting	-10%

Gerimex b.v. Telefoon +31 74 2436655 . info@gerimex.com . www.gerimex.com

Snelwisselsnijbus type BTB

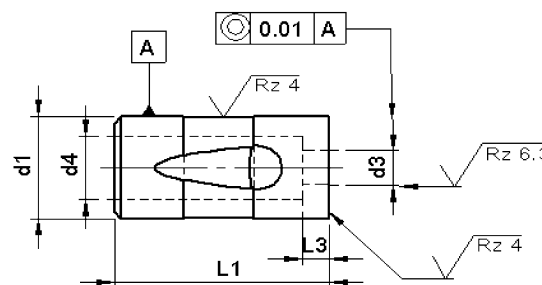
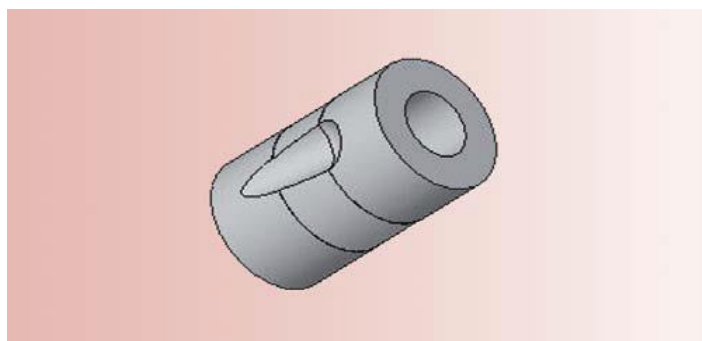

d_1 h_5	l_3	d_3 $+0.01$ 0		d_4	l_1 $+0.2$ 0	Prijs per stuk in EURO
		\geq	\leq			
13	3,5	3	- 7	7.5	32	21,82
16	4	4	- 8	9		24,97
20	4,5	6	- 11	12		41,77
25	5	12	- 16	17		55,42
32	6	13	- 20	22		66,97
38	6	16	- 26	28		103,72
63,5	7	25	- 50	51		157,50

Tusseliggende diameter of lengte en andere materialen zoals ASP, CPM en Vanadis, prijs op aanvraag.

Toeslagen en kortingen:

- 1 stuks per afmeting + 50%
- 2-3 stuks per afmeting + 25%
- 25 stuks per afmeting - 5%
- 50 stuks per afmeting - 7%
- 100 stuks per afmeting - 10%

Snelwisselsnijbus type BTB.. Met standaard profielvormen



Blad 6.12

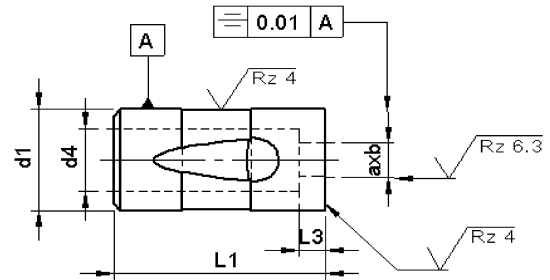
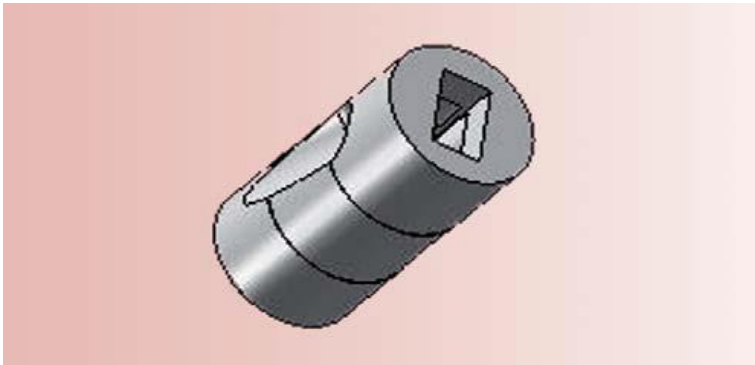

Materiaal: HWS (1.2379)
Hardheid: Schacht: 64 ±2 HRC

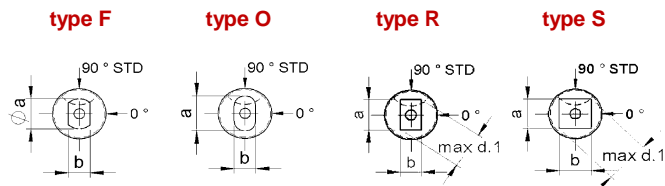

d ₁ h5	l ₃	AxB			d ₄	l ₁ +0,2 0	Prijs per stuk in EURO
		B ≥	+0.01 0	A ≤			
13	3,5	3	-	7	32	21,82	
16	4	4	-	8		24,97	
20	4,5	6	-	11		41,77	
25	5	12	-	16		55,42	
32	6	13	-	20		66,97	
38	6	16	-	26		103,72	
63,5	7	25	-	50		157,50	

Tusseliggende diameter of lengte en andere materialen zoals ASP, CPM en Vanadis, prijs op aanvraag.

Toeslagen en kortingen:

1 stuks per afmeting	+ 50%
2-3 stuks per afmeting	+ 25%
25 stuks per afmeting	- 5%
50 stuks per afmeting	- 7%
100 stuks per afmeting	- 10%

Gerimex b.v. Telefoon +31 74 2436655 . info@gerimex.com . www.gerimex.com

Boorbussen DIN 172 a Met kraag



Blad 7.01

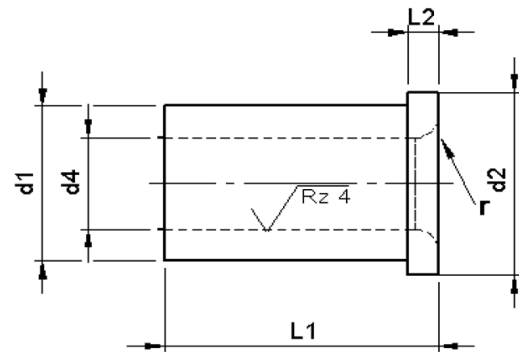

Materiaal: 1.7262
Hardheid: 62-65 HRC

d ₄ F ₇	t/m	d ₃ n ₆	l ₁ kort				EURO	l ₁ middel		EURO	l ₁ lang		EURO
0,4	t/m	1,0	3	6	2	6							
1,1	t/m	1,8	4	7	2	6							
1,9	t/m	2,6	5	8	2	6	6,45	9	6,96				
2,7	t/m	3,3	6	9	2,5	8	4,85	12	4,02				
3,4	t/m	4,0	7	10	2,5	8	3,89	12	4,21	16	18,48		
4,1	t/m	5,0	8	11	2,5	8	4,02	12	4,28	16	18,48		
5,1	t/m	6,0	10	13	3	10	4,15	16	4,34	20	23,10		
6,1	t/m	8,0	12	15	3	10	4,28	16	4,79	20	23,10		
8,1	t/m	10,0	15	18	3	12	4,79	20	5,23	25	28,88		
10,1	t/m	12,0	18	22	4	12	5,17	20	5,87	25	28,88		
12,1	t/m	15,0	22	26	4	16	5,87	28	6,83	36	41,58		
15,25	t/m	18,0	26	30	4	16	6,83	28	8,68	36	41,58		
18,25	t/m	22,0	30	34	5	20	7,98	36	10,34				
22,25	t/m	26,0	35	39	5	20	10,34	36	14,04				
26,25	t/m	30,0	42	46	5	25	13,40	45					
30,25	t/m	35,0	48	52	5	25	15,83	45					
35,50	t/m	40,0	55	59	5	30	20,74	56					

Boorbussen DIN 179 a

Zonder kraag

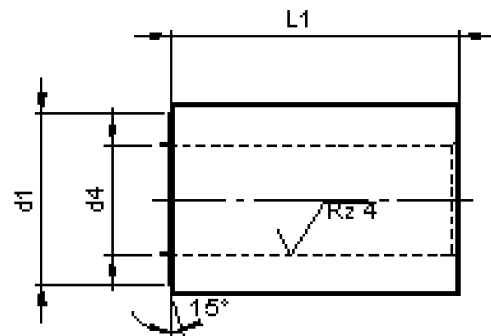
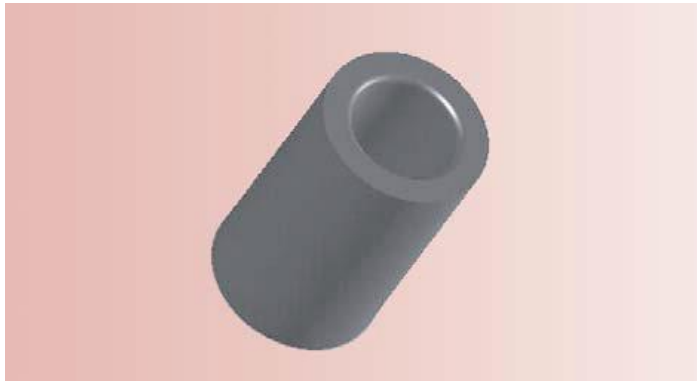

Materiaal: 1.7262
 Hardheid: 62-65 HRC

d ₄ F ₇	t/m	d ₁ n ₆	Prijs per stuk in EURO							
			l ₁ kort	EURO	l ₁ middel	EURO	l ₁ lang	EURO		
0,4	t/m	1,0	3	6	*		9	*		*
1,1	t/m	1,8	4	6	4,09	9	5,62			
1,9	t/m	2,6	5	6	2,81	9	3,77			
2,7	t/m	3,3	6	8	4,15	12	3,13	16	6,06	
3,4	t/m	4,0	7	8	3,00	12	3,19	16	4,56	
4,1	t/m	5,0	8	8	3,19	12	3,38	16	4,86	
5,1	t/m	6,0	10	10	3,19	16	3,64	20	4,98	
6,1	t/m	8,0	12	10	3,64	16	3,89	20	5,35	
8,1	t/m	10,0	15	12	3,89	20	4,60	25	6,32	
10,1	t/m	12,0	18	12	4,60	20	5,23	25	6,75	
12,1	t/m	15,0	22	16	4,98	28	6,64	36	8,88	
15,25	t/m	18,0	26	16	5,94	28	7,98	36	10,27	
18,25	t/m	22,0	30	20	8,04	36	10,85			
22,25	t/m	26,0	35	20	10,15	36	12,89			
26,25	t/m	30,0	42	25	12,19	45	14,94			
30,25	t/m	35,0	48	25	15,70	45				
35,50	t/m	40,0	55	30	20,81	56				

*prijs en levertijd op aanvraag

Geleidepen type G100

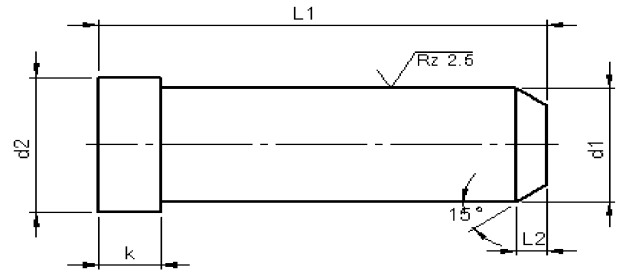
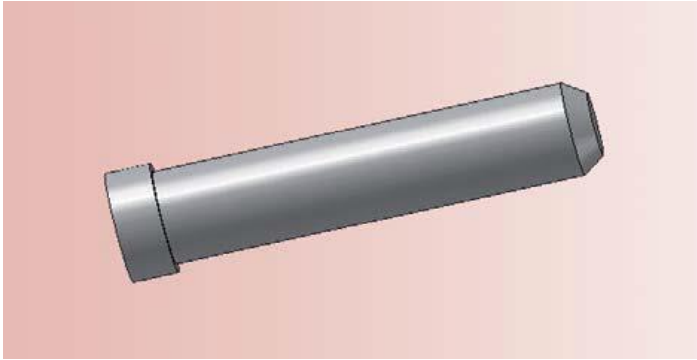

Materiaal: 1.7262
 Hardheid: 60 ±2 HRC

d ₁ g ₆	10	12	14	16	18	20	22	24	26
d ₂	12	16	18	20	22	24	26	28	30
k -0,2	3	6	8	8	8	8	15	15	15
	Prijs per stuk in EURO								
40	5,25	5,57							
60	5,41	6,04	6,30	6,77	7,35				
80	5,57	6,46	6,62	7,35	9,14	9,03	10,50		
100	6,20	7,19	7,67	8,40	9,14	10,08	11,87	13,49	17,60
120	7,05	7,93	8,40	9,45	10,34	11,97	14,44	16,07	20,15
140	11,39	8,87	10,08	10,97	11,87	13,23	15,91	17,27	22,45
160	14,49	9,61	11,87	12,60	13,23	14,70	17,27	18,74	24,75
180			13,39	14,12	15,07	16,70	18,95	20,42	26,90
200			18,17	15,59	16,49	18,95		21,95	29,05
220			19,22	17,12	18,74	20,84	23,57	25,36	39,05
240				23,10	24,15	24,41		28,67	
260								34,65	

Stelpen DIN 6325

Passing m6/h6



Blad 8.01

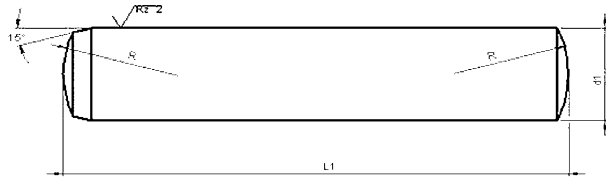
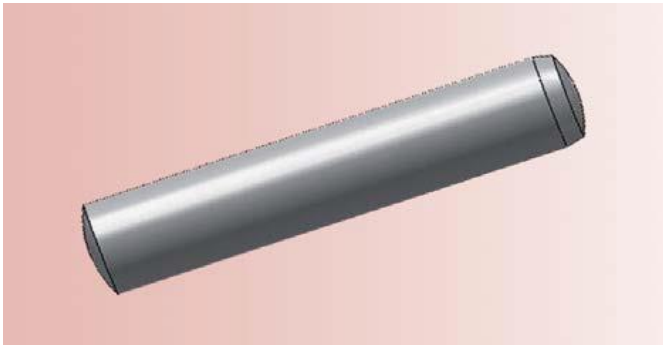

Materiaal: Geslepen + gelept
Hardheid: 60 ±2 HRC

Prijs per 100 stuks in EURO (m6- passing)

L	1,5	2	3	4	5	6	8	10	12	14	16	20
4	7,82											
6	8,14	4,67	5,41	7,88								
8	8,46	5,25	6,04	7,88	9,98	19,27						
10	8,82	5,67	6,77	9,29	10,13	16,59						
12	9,29	6,25	7,35	10,34	11,13	19,22						
14	10,66	6,88	8,14	9,61	14,81	16,86	26,83					
16	10,03	7,25	8,77	10,13	14,28	17,90	28,09					
18	9,98	8,19	9,56	11,18	15,02	21,63	29,93	44,78				
20	10,66	8,35	10,45	11,66	16,54	22,73	31,45	46,52	62,95			
24	12,66	9,61	10,40	13,02	17,59	25,10	35,33	55,28	68,62			
28		11,24	11,76	14,44	20,79	27,72	39,85	55,60	74,55			
32			12,76	16,22	22,16	30,35	42,74	63,05	84,16			
36			14,12	17,27	24,26	32,45	47,09	70,72	91,61	191,10		
40			16,17	19,11	24,31	34,97	49,09	74,71	93,45	186,90	227,85	
45				56,65	28,25	36,86	54,76	83,37	103,95	226,80	258,30	417,90
50					30,24	40,90	59,01	89,20	114,19	208,95	265,65	466,20
60					53,76	57,91	83,48	103,85	130,73	250,95	304,50	537,60
70					71,40	68,25	112,60	142,80	168,53	278,25	346,50	589,05
80						85,63	121,80		204,38	352,80	403,20	684,60
90						106,05	160,65		277,36	435,75	507,15	786,45
100						144,90	191,10		305,80	439,95	498,75	804,30
120							236,25		392,65	523,95	583,80	916,65

Minimum order aantal.

- afm. 1,5 t/m 5 100 stuks per afmeting
- afm. 6 t/m 8 50 stuks per afmeting
- afm. 10 t/m 20 10 stuks per afmeting

Passing h6 prijs m6 + 25 %

Gerimex b.v. Telefoon +31 74 2436655 . info@gerimex.com . www.gerimex.com

Stelpen DIN 7979 D

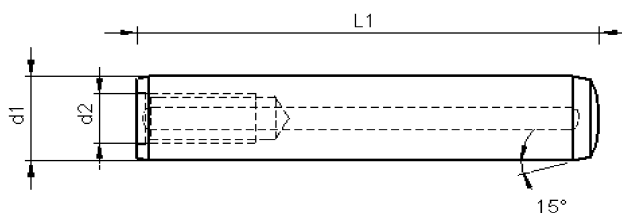
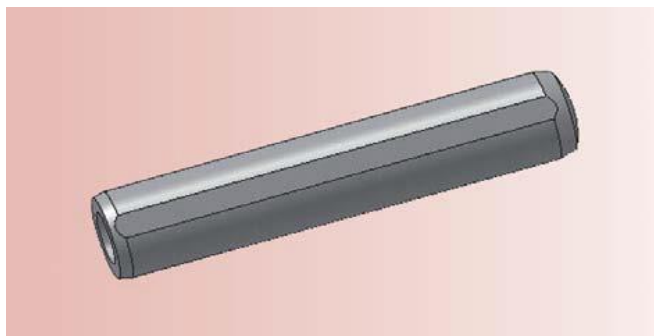

Materiaal: Geslepen + gelept
Hardheid: 60 ±2 HRC

d ₁ m ₆	4	5	6	8	10	12	14	16	20
d ₂	M3	M3	M4	M5	M6	M6	M8	M8	M10
l ₁	Prijs per 100 stuks in EURO								
10	47,67	45,10							
12	49,35	30,45	37,80						
14	51,45	32,03	37,80						
16	55,49	50,03	37,80	56,02	129,15				
18	66,05	51,08	39,48	56,02					
20	60,90	52,03	39,48	56,02	55,86	141,75			
24	68,25	53,45	41,21	57,07	61,95	77,60			
28	78,75	55,44	43,16	56,02	68,88	87,52			
32	100,70	57,44	45,04	58,74	76,13	95,87	245,70	200,18	
36	90,04	39,27	47,09	61,48	87,78	103,90	278,25	221,55	
40	91,82	61,27	49,93	64,31	92,03	112,51	266,70	245,70	424,20
50	313,95	65,99	57,75	80,75	108,41	134,03	298,20	299,25	500,85
60			73,50	99,75	126,11	154,35	327,60	325,50	565,95
70			141,75	111,30	169,37	196,35	381,15	366,45	656,25
80				126,00	190,21	221,55	432,60	435,75	730,80
90				213,15	288,75	344,40	612,15	495,60	882,00
100				234,15	329,70	366,45	520,80	550,20	823,20
120				309,75	404,25	447,30	708,75	635,25	893,55

Minimum order aantal:

Ø 4 t/m Ø 8 50 stuks per afmeting
 Ø 10 t/m Ø 20 25 stuks per afmeting